



JVC

SERVICE MANUAL

LINEAR TRACKING FULLY-AUTOMATIC TURNTABLE

MODEL QL-G90B

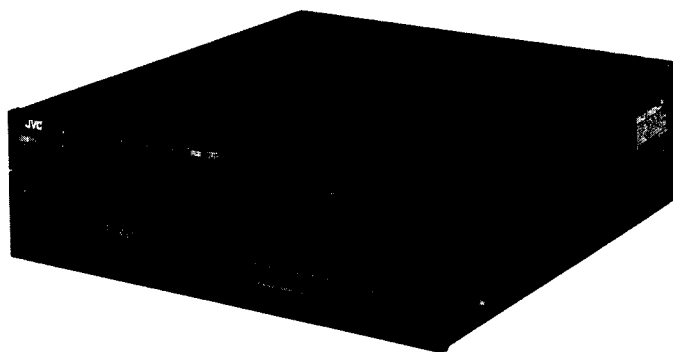

Contents

	Page		Page
Safety Precautions	1- 1	10. Block Diagram	1-11
1. Features	1- 2	11. Check of Power Supply P.C. Board	1-11
2. Specifications	1- 2	12. Adjustment Procedures	1-12
3. Controls and Functions	1- 3	12-(1) Lead-In Adjustment	1-12
4. Servicing Precautions	1- 5	12-(2) Offset Adjustment	1-12
5. Technical Explanation	1- 5	12-(3) Track Interval Detection Sensor Sensitivity Adjustment	1-12
5-(1) Programmed Music Scan	1- 5	12-(4) Detect Position (Touch-Down Position) Adjustment	1-12
5-(2) Explanation of Microprocessor Pins (MB88401M/292K)	1- 6	13. Connection Diagram	1-13
6. Stylus Replacement	1- 8	14. Troubleshooting	1-14
6-(1) Removal	1- 8	14-(1) When Tonearm Action is Abnormal	1-14
6-(2) Attachment	1- 8	14-(2) When Turntable Operation is Abnormal	1-17
7. Cartridge Replacement	1- 8	14-(3) When Music Scan Operation is Abnormal	1-21
8. Disassembly	1- 9	15. Standard Circuit Diagram	1-22
8-(1) Disassembly Procedure	1- 9	16. Power Cord Connections in Different Areas	1-24
8-(2) Removal and Attachment of Platter Compartment Door	1-10	Parts List	Separate-volume Insertion
9. Rope Suspension	1-10		

Safety Precautions

1. The design of this product contains special hardware, many circuits and componets specially for safety purposes.
For continued protection, no changes should be made to the original design unless authorized in writing by the manufacturer. Replacement parts must be identical to those used in the original circuits. Service should be performed by qualified personnel only.
2. Alterations of the design or circuity of the product should not be made. Any design alterations or additions will void the manufacturer's warranty and will further relieve the manufacturer of responsibility for personal injury or property damage resulting therefrom.
3. Many electrical and mechanical parts in the product have special safety-related characteristics. These characteristics are often not evident from visual inspection nor can the protection afforded by them necessarily be obtained by using replacement components rated for higher voltage, wattage, etc. Replacement parts which have these special safety characteristics are identified in the parts list of Service manual. Electrical components having such features are identified by shading on the schematics and by (Δ) on the parts list in Service manual. The use of a substitute replacement which does not have the same safety characteristics as the recommended replacement part shown in the parts list in Service manual may create shock, fire, or other hazards.
4. The leads in the products are routed and dressed with ties, clamps, tubings, barriers and/or the like to be separated from live parts, high temperature parts, moving parts and/or sharp edges for the prevention of electric shock and fire hazard.
When service is required, the original lead routing and dress should be observed, and they should be confirmed to be returned to normal, after re-assembling.

5. Leakage current check

(Safety for electrical shock hazard)

After re-assembling the product, always perform an isolation check on the exposed metal parts of the Products (antenna terminals, knobs, metal cabinet, screw heads, headphone jack, control shafts, etc.) to be sure the product is safe to operate without danger of electrical shock.

Do not use a line isolation transformer during this check.

- Plug the AC line cord directly into the AC outlet. Using a "Leakage Current Tester", measure the leakage current from each exposed metal part of the cabinet, particularly any exposed metal part having a return path to the chassis, to a known good earth ground. Any leakage current must not exceed 0.5 mA AC (r.m.s.).
- Alternate check method
Plug the AC line cord directly into the AC outlet. Use an AC voltmeter having 1,000 ohms per volt or more sensitivity in the following manner. Connect a 1500 Ω 10 W resistor paralleled by a 0.15 μ F AC-type capacitor between an exposed metal part and a known good earth ground. Measure the AC voltage across the resistor with the AC voltmeter.
Move the resistor connection to each exposed metal part, particularly any exposed metal part having a return path to the chassis, and measure the AC voltage across the resistor. Now, reverse the plug in the AC outlet and repeat each measurement. Any voltage measured must not exceed 0.75 V AC (r.m.s.). This corresponds to 0.5 mA AC (r.m.s.).

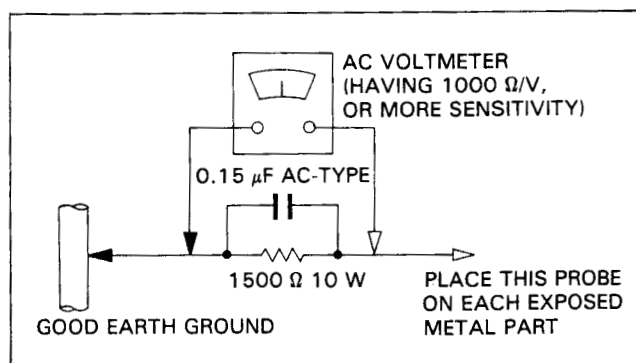

CHECKING YOUR LINE VOLTAGE (For U.S. Military Market and Other Countries)

Before inserting the power plug, please check this setting to see that it corresponds with the line voltage in your area. If it doesn't, be sure to adjust the voltage selector switch to the proper setting before operating this equipment. The voltage selector switch is located bottom board.

CAUTION Before selecting the "Voltage selector switch" to proper voltage disconnect the power plug.

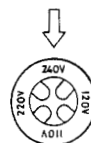

1. Features

- Front-loading/front-control design
- Linear tracking for zero tracking error
- Double-Servo Quartz control
- Random programming of 8tracks for up to 15 plays
- Index play for sampling intros
- Plug-in cartridge connector

2. Specifications

Motor Section

Motor : Quartz locked coreless FG servo motor

Drive system : Direct drive

Speeds : 33-1/3 rpm, 45 rpm

Wow and flutter : 0.025% (WRMS)
0.015% (RMS, motor section
measured by FG method)

S/N : 78 dB (DIN-B)

Tonearm Section

Type : Linear tracking statically balanced
low mass straight arm

Effective length : 105 mm

Tracking error : +15'

Cartridge Section

Model : Z-45EP

Type : Moving magnet (MM)

Frequency response : 10 Hz—25,000 Hz

Output : 2.5 mV (1 kHz)

Channel separation : 25 dB/1 kHz (test record: TRS-1)

Load resistance : 47 kohms

Tracking ability : 70 μ m at 315 Hz

Compliance : 9×10^{-6} cm/dyne

Stylus tip : 0.1 \times 0.2 mm square block diamond
elliptic stylus (0.3 \times 0.7 mil)

Stylus : DT-45E

Tracking force : 1.25 g

General

Dimensions : 340(W) \times 108(H) \times 356(D) mm
(13-1/16" \times 4-5/16" \times 14-1/16")
(Since the dimensions show only the
design measurements, an allowance
is required when installing the unit in
a limited space such as a rack, etc.)

Weight : 8.6 kg (19.0 lbs)

Design and specifications subject to change without notice.

POWER SPECIFICATIONS

Countries	Line Voltage & Frequency	Power Consumption
U.S.A. & CANADA	AC 120 V \sim , 60 Hz	20watts
CONTINENTAL EUROPE	AC 220 V \sim , 50 Hz	18watts
U.K. & AUSTRALIA	AC 240 V \sim , 50 Hz	
U.S. MILITARY MARKET	AC 110/120/220/ 240 V \sim selectable, 50/60 Hz	
OTHER AREAS	AC 110/120/220/240 V \sim selectable, 50/60 Hz	

3. Controls and Functions

1 POWER

Press this button to apply power to the unit. The display window shows "O", indicating that power is on (ON). To switch off (STAND BY) the unit, press this button once more. The "O" will go out.

Note: This unit has a power consumption of 2.5 W even when the power was turned off by means of the POWER switch. Therefore, if the unit is not to be used for a long time, remove the AC plug from the outlet. If a convenience outlet of an amplifier is used, the AC plug of the amplifier should be disconnected also. If the POWER switch is depressed while the platter is in the extended position or the tonearm has not returned to its rest, the POWER will not be switched off before the platter is drawn in and the tonearm has returned to its rest position.

2 SPEED

33: Platter rotates at 33-1/3 rpm regardless of the type of record.

AUTO: The unit automatically selects 33-1/3 rpm for 30-cm records and 45 rpm for 17-cm records.

45: Platter rotates at 45 rpm regardless of the type of record.

3 CLEAR

This button is used to clear the playback memory. When this button is pressed during programmed playback of a track, playback is released.

Note: Pressing the START/STOP or the OPEN/CLOSE button during playback also results in clearing the memory and releasing playback.

4 REPEAT

This button is pressed for REPLAY. When pressed, the REPEAT indicator lights up. As long as the REPEAT indicator is lit, the record will be repeated continuously. By using the program memory, a selection of up to 15 tracks can be played back repeatedly in the designated order. To discontinue replay, press the REPEAT button once more to turn off the REPEAT indicator or press either the START/STOP or OPEN/CLOSE button.

5 INDEX

If you wish to know the content of a certain program press this button to play back only the introduction of that program. This feature will play back the first 10 seconds of each program, in the order of the programs selected when the Program Select function has been used, and in numerical order from the first program when such is not the case.

Press the CLEAR button, the START/STOP button, or the OPEN/CLOSE button to disengage the INDEX function.

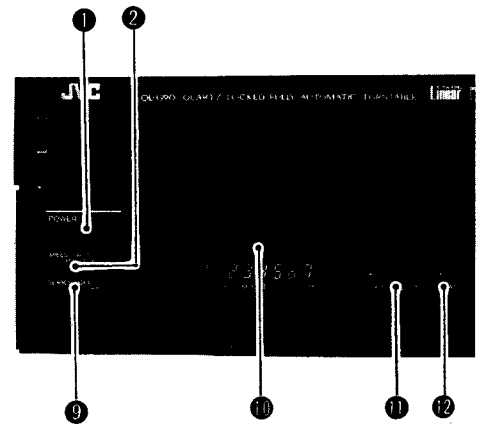

6 SKIP

This button is used to interrupt playback of a track and proceed directly to the next.

Note:

- During manual playback the skip function is inactive.
- When a number of tracks is programmed, the skip function will cause playback from the next programmed track.

7 UP/DOWN

Pressing this button while the tonearm is raised lowers it and pressing the button while the tonearm is on the disc will raise the tonearm. Use this control for temporary interruption of playback or to lower the tonearm onto the record during manual playback, after it was moved by means of the "<" or ">" buttons.

Note: If playback was temporarily interrupted by means of the UP/DOWN button during automatic playback, the SKIP button can be used to proceed to the next track.

8 OPEN/CLOSE

Pressing this button causes the platter to slide out or to retract.

9 SENSOR

L : If the tonearm sets down before the beginning of the designated track, set the switch to this position.

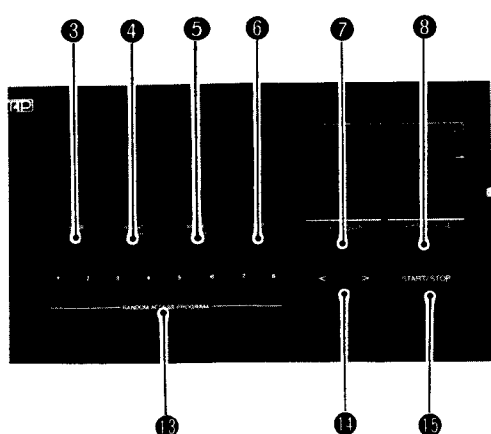

NORM: During normal operation, the switch should be set the this position.

H : If the tonearm passes over the designated track, set the switch to this position.

Note: When the position of the SENSOR switch was changed, always slide the platter out and in again, and then cause the tonearm to perform search operation.

10 Display Panel

Power On:

"0" is displayed in red at left.

Automatic Playback:

The number of the track presently playing is displayed in red at left.

Programmed Playback:

Starting from left, the numbers of programmed tracks are displayed in the designated order. The track to be played first or the track presently playing is indicated in red, the other tracks in orange color. Up to 15 tracks can be programmed, but the display covers 8 tracks.

Manual Playback:

All indicators are out.

11 Quartz Lock Indicator

When the platter rotation is stabilized by the quartz lock circuit, the "Quartz" logo will light up.

12 REPEAT Indicator

When the REPEAT button is pressed, this indicator lights up in red. While the indicator is lit, the record will be repeated continuously.

13 RANDOM ACCESS PROGRAM

Choose the desired track number for programmed playback with these buttons. The unit can differentiate between up to 8 tracks for one side of a record, and a maximum of 15 track number entries can be stored in the memory. If more than 8 tracks are programmed, the first 8 are displayed, and the display moves one step to the left every time a track is completed.

14 <•>

During manual playback, the tonearm can be moved to the left or right with these buttons. The tonearm keeps moving for as long as the button is depressed and stops when the button is released.

15 START/STOP

This button is used to start automatic playback or to interrupt playback of a record. Pressing it during standby initiates "Start" and pressing it during playback initiates "Stop".

Note: Pressing the START/STOP button during repeat playback or programmed playback results in cancellation of the respective operation.

4. Servicing Precautions

1. If the tonearm, motor or any other mechanical parts were detached, disassembled or replaced, always perform check and adjustment of lead-in position.
2. Be sure to perform servicing related to motor revolution only on a level surface.
3. As the rotor of the drive motor is magnetic, special care must be taken not to contaminate the rotor during servicing by attracting metallic particles or the like.
4. The power cord is connected to the primary leads of the power transformer by means of crimp-on terminals. If this connection has to be removed, re-establish it only with crimp-on connectors and confirm that secure connection has been established.
5. For check procedures of the logic circuit, refer to "Check Procedure of Main PCB" on page 1-11.

6. This unit employs the lubricators and bonds specified below. Be sure to use only the designated types.

Brand		Application
Furoil GP-501A Furoil BG-TS-1 (Kanto Kasei Co)	(A) 1:1 Ratio	Worm and worm gear teeth contact area Bearings on both sides of worm assembly Gustand mesh section Rack gear mesh section Roller section at rear of tonearm
White Grease	(B)	V-groove of loading guide
Furoil GP-608	(C)	Shaft A, Shaft B

5. Technical Explanation

5-(1) Programmed Music Scan

As opposed to conventional designs, this unit does not use a sensor incorporated into the cartridge, but employs a separate sensor which moves in sync with the tonearm, as shown in the illustration.

1. Detector circuit

This circuit operates in the same way as described in "Optical Detection in UP Position" of the Service Manual for model QL-E55 (No. 2665 Mar. 1983) published previously.

2. Music scanning

When the turntable is activated - except in the manual mode - the tonearm and sensor scan the total record area from the outside to the inside before playback, and the position of the intervals (MARKER SPACE) between musical tracks are stored in the microprocessor (by number of pulses in the rotary encoder). During programmed playback, these data are used to lower the tonearm at the beginning of a designated track and lift it at the end of the track.

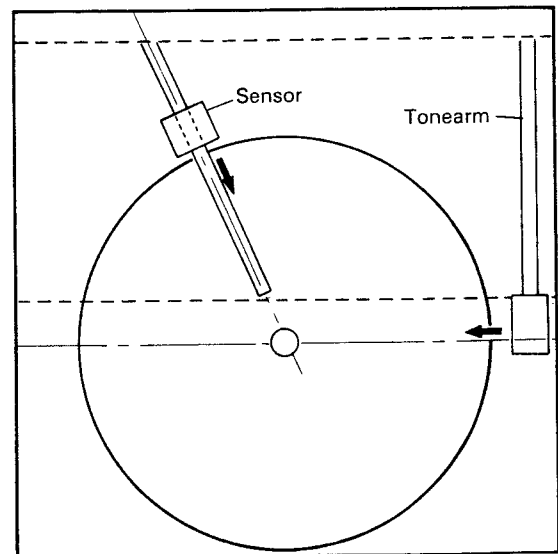

Fig. 1

5-(2) Explanation of Microprocessor Pins (MB88401M/292K)

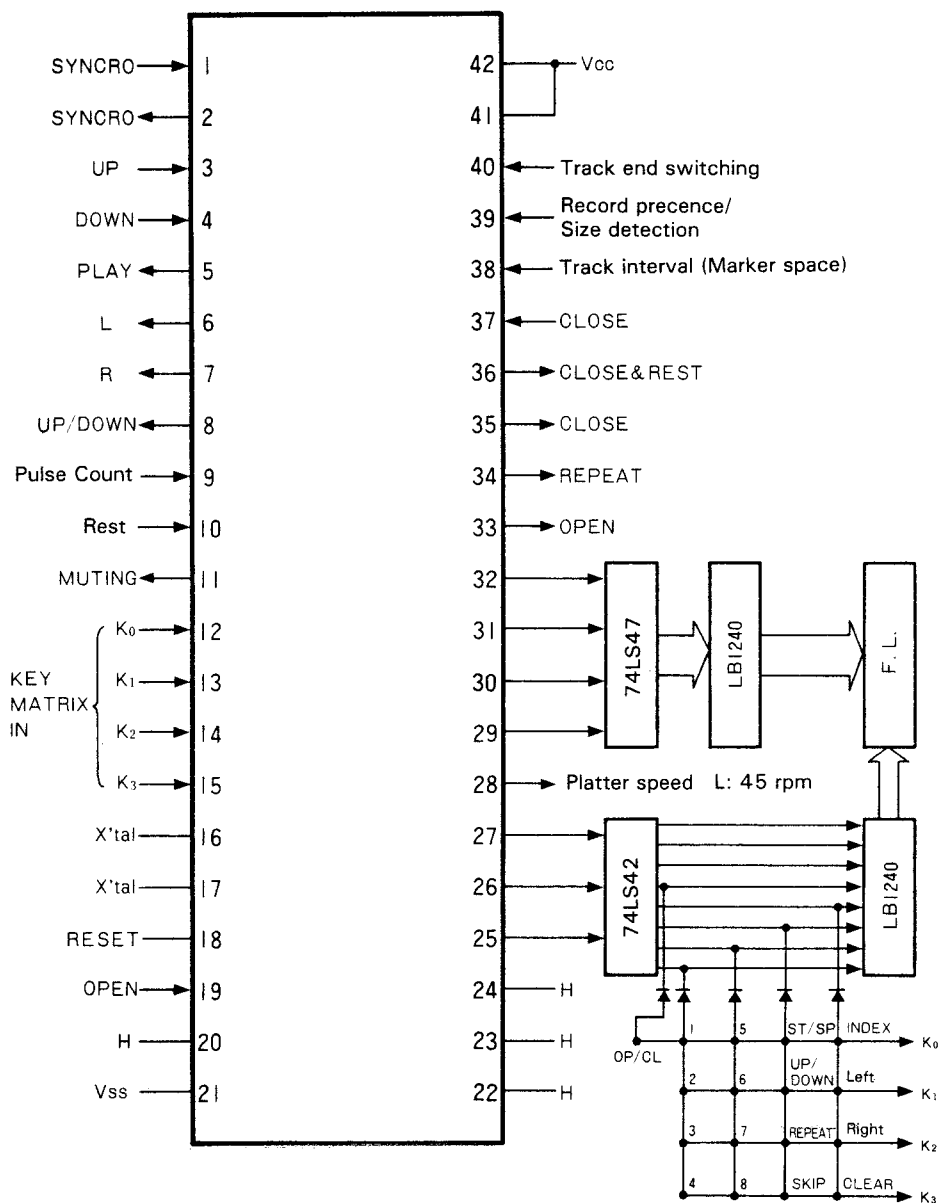

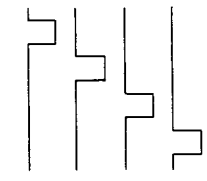

Fig. 2

PIN No.	PORT NAME	INPUT/OUTPUT	COMMENT	
1	R4	I	DCS Input Terminal	
2	R5	O	DCS Output Terminal	
3	R6	I	UP Signal Input Terminal	H → UP
4	R7	I	DOWN Input Terminal	H → DOWN
5	R8	O	PLAY Signal Output Terminal	L → PLAY
6	R9	O	L Signal Output Terminal	L → L
7	R10	O	R Signal Output Terminal	L → R
8	R11	O	UP/DOWN Signal Output Terminal	H → UP
9	R12	I	PULSE COUNT Input (approx. 10 msec cycle)	 (during arm movement)
10	R13	I	REST Signal Input Terminal	H → REST
11	R14	O	MUTING Output Terminal	H → MUTING ON
12	K0	I	KEY MATRIX INPUT	 (When any key is pressed.)
13	K1			
14	K2			
15	K3			
16	EX	}	Microprocessor Clock Pulse Terminal	4.19 MHz
17	X			
18	RESET		Reset Terminal	L → During RESET
19	IRQ	I	OPEN Input Terminal	H → OPEN
20	TC	—		H
21	Vss	Power Supply	OV	L
22	SC/T0	—		H
23	Si	—		H
24	S0	—		H
25	O0	}	BCD Output Terminal	
26	O1			
27	O2			
28	O3	O	33/45 Output Terminal	H → 33
29	O4	}	7-Segment Output Terminal	
30	O5			
31	O6			
32	O7			
33	P0	O	CLOSE Output Terminal	L → CLOSE
34	P1	O	REPEAT Output Terminal	L → REPEAT · ON
35	P2	O	OPEN Output Terminal	L → OPEN
36	P3	O	CLOSE & REST Output Terminal	L → CLOSE & REST
37	R0	I	CLOSE Input Terminal	L → CLOSE
38	R1	I	Track Interval Input Terminal	H → Track Interval
39	R2	I	Record Presence & Size Detection	H → 17 cm (30 cm circumference) H → None (on PLATTER MAT)
40	R3	I	PULSE COUNT switching	L → 0 H → -3
41	VM	} Power Supply	5V	
42	Vcc			

6. Stylus Replacement

6-(1) Removal

Pull out the stylus assembly steadily in direction of the arrow, as shown in the illustration. Do not pull the assembly forward or at an angle to the cut-out.

Note: Stylus replacement is facilitated by removing the cartridge first.

6-(2) Attachment

Fit the protruding section of the stylus assembly into the cut-out on the cartridge and slide the assembly smoothly in, as shown in the illustration. Do not slide at an angle to the cut-out.

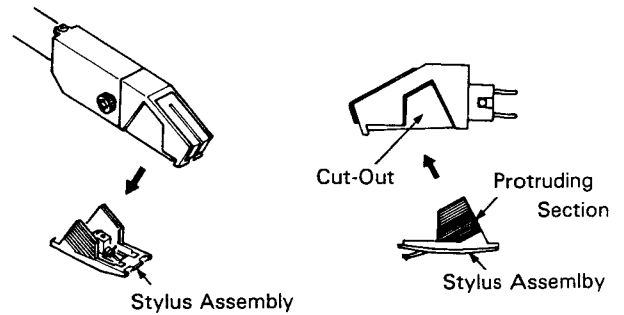

Fig. 3

7. Cartridge Replacement

This unit is designed for use with [T4P] plug-in type cartridges. Cartridge replacement with another cartridge of this type is possible. For replacement, loosen the fastening screw of the cartridge and pull the cartridge out, as shown in the illustration.

Note: Be sure to use the cartridge fastening screw of this unit even with another cartridge, in order to ensure correct tracking force.

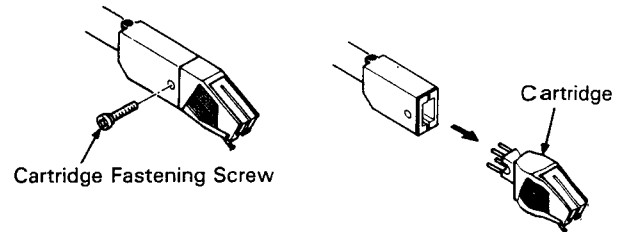

Fig. 4

8. Disassembly

8-(1) Disassembly Procedure

1. Removal of metal cover

Remove the four screws on both sides of the unit and the five screws on the rear panel of the unit, and pull the cover straight up while slightly spreading it.

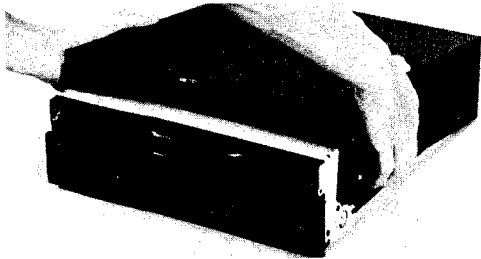
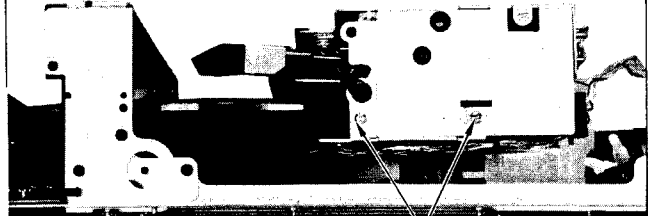

Fig. 5

2. Removal of mechanism base ass'y

Remove the five screws (on both sides and upper) of the unit shown in the illustration, and unhook the wire in the rear from its clamp to loosen it. Then pull the base straight up.



Screws

Fig. 6

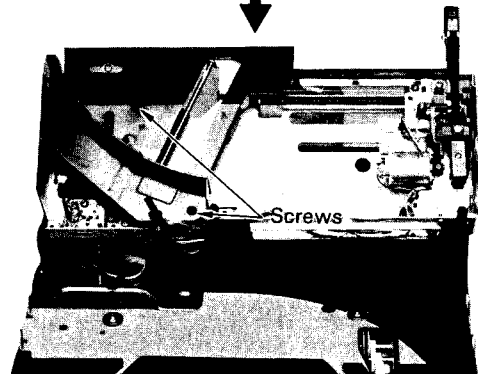

Screws

Fig. 7

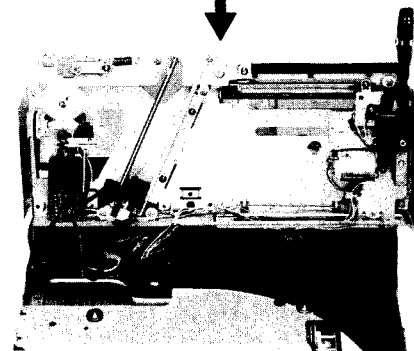
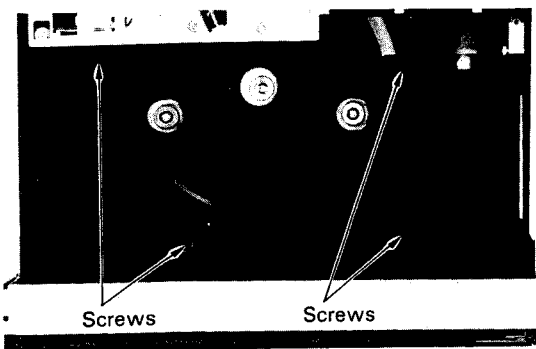

Fig. 8

3. Removal of main drive motor

Take off the platter and loosen the four screws shown in the illustration. Lift the cabinet up.

Note: Be careful not to disturb the cartridge stylus or the sockets and wires on the PCB.



Screws

Screws

Fig. 9

Removal screws ① ~ ④ shown in Fig. 10, and remove the motor.

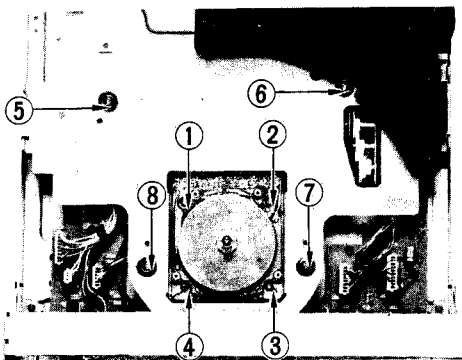

Fig. 10

4. Removal of Loading Drive Motor

Remove screws ⑤ ~ ⑧ shown in Fig. 10, and remove the turntable board.

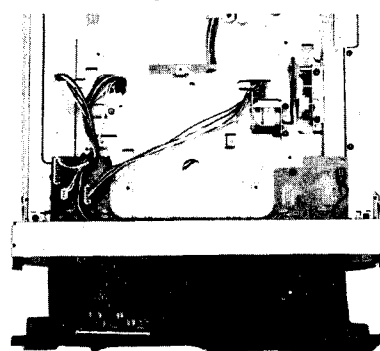

Fig. 11

8-(2) Removal and Attachment of Platter Compartment Door

1. Remove screws ① and ② shown in the illustration, and pull out the cam to remove the door.

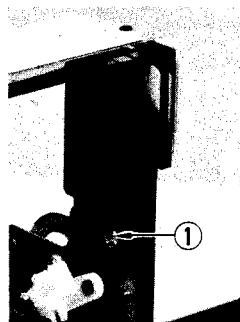

Fig. 12

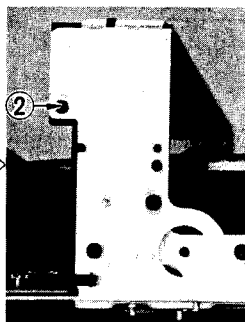

Fig. 13

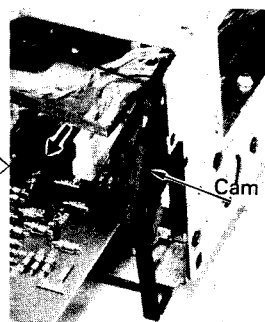

Fig. 14

2. To attach the door, reverse the procedure. Push the door lever by hand and insert the projection (A) into the slot.

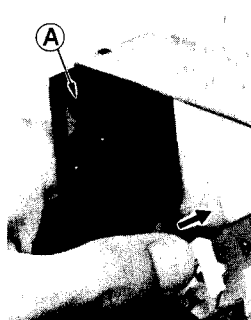

Fig. 15

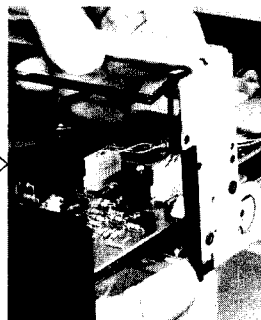

Fig. 16

9. Rope Suspension

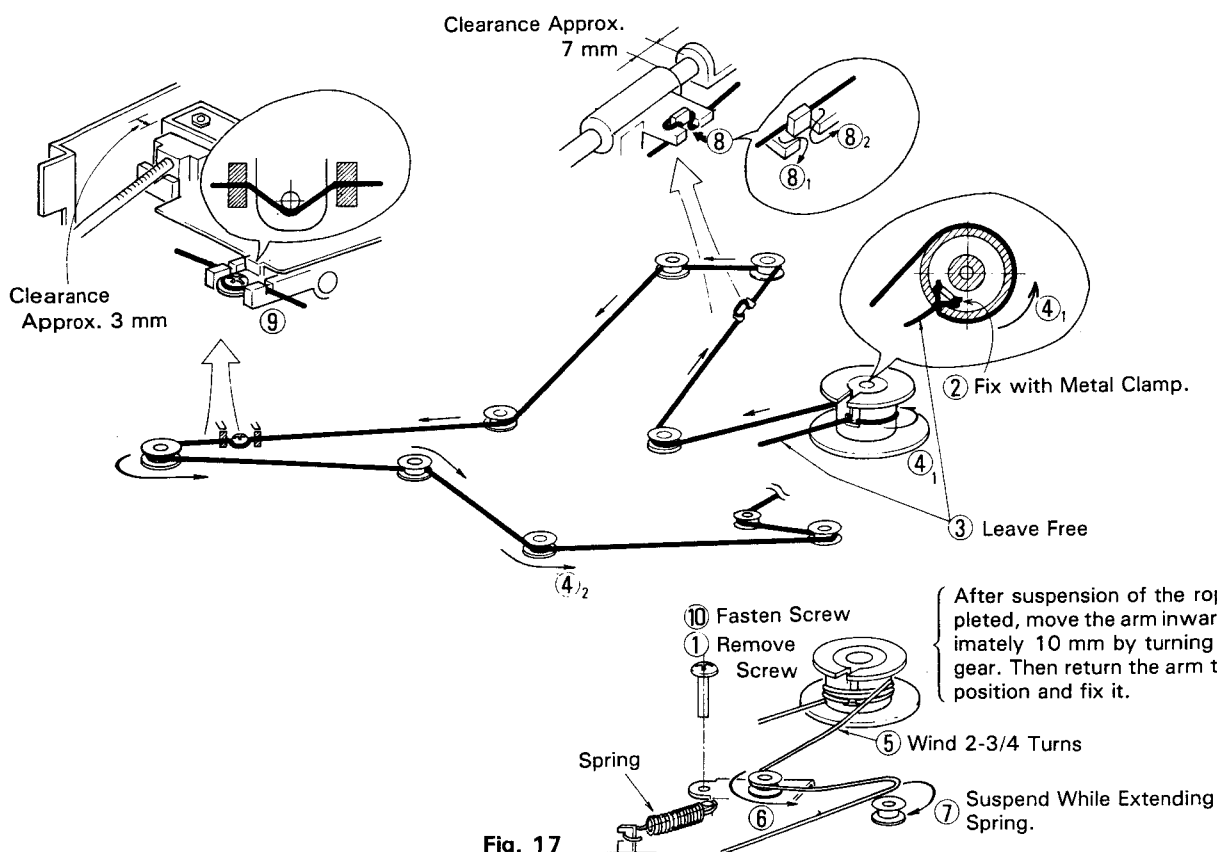

Fig. 17

10. Block Diagram

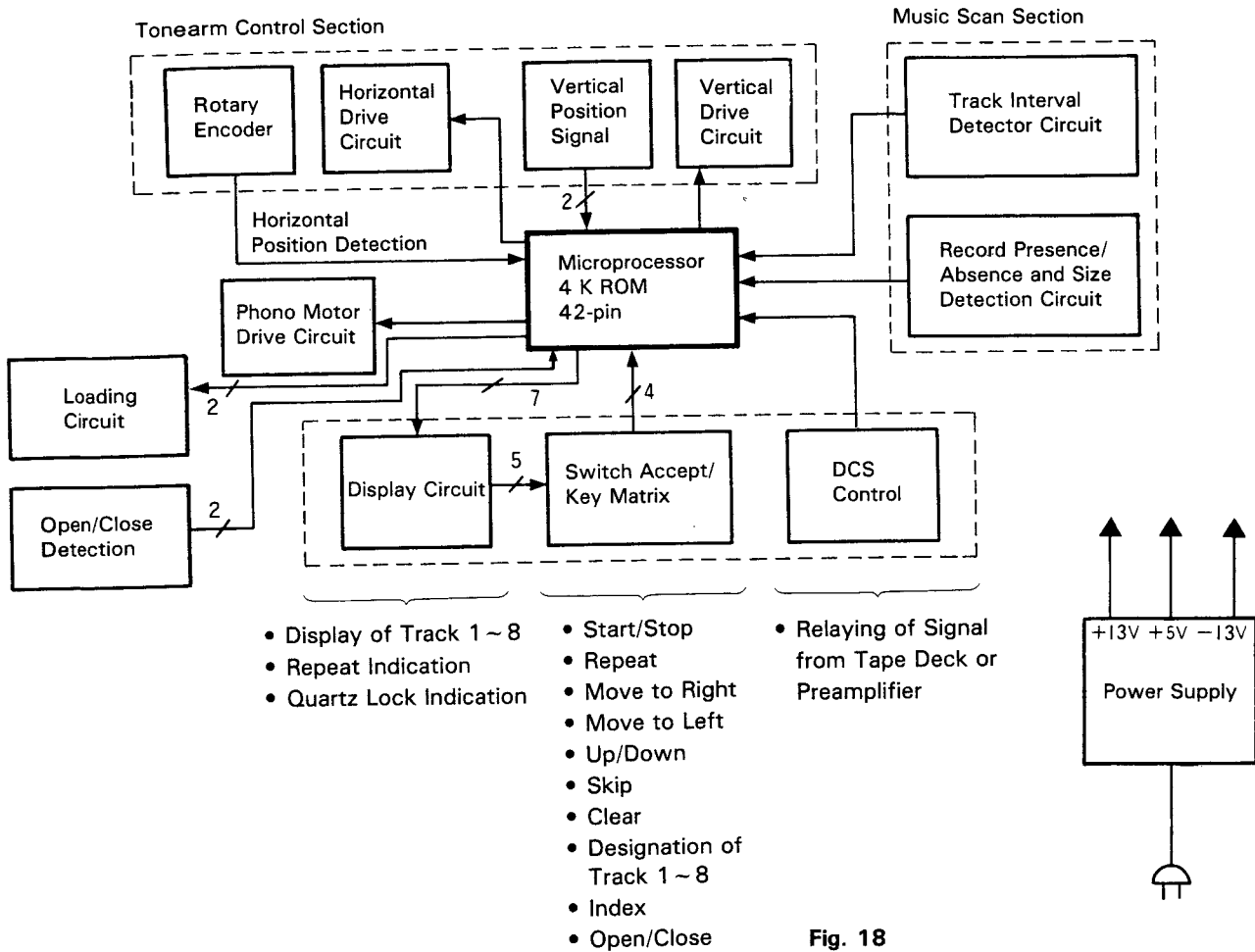

Fig. 18

11. Check of Power Supply P.C. Board

To check the power supply circuit and logic circuit in the playback mode, the loading mechanism must be in the open condition.

- To open the loading mechanism, short-circuit pin 3 and pin 4 of P903.

1. Remove the platter and cabinet. (Refer to "Disassembly", step 3)
2. Set the loading mechanism to the open condition.
3. Re-install the platter and switch on the power.

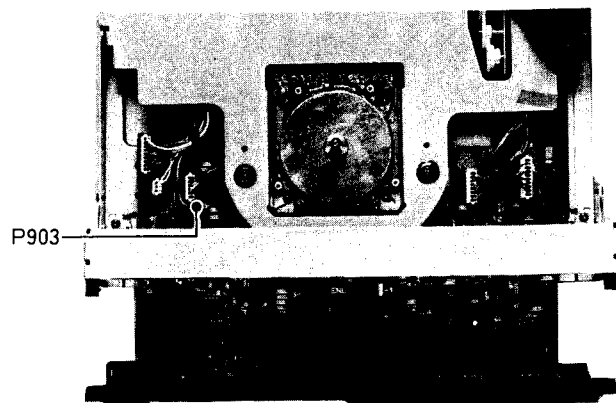

Fig. 19

12. Adjustment Procedures

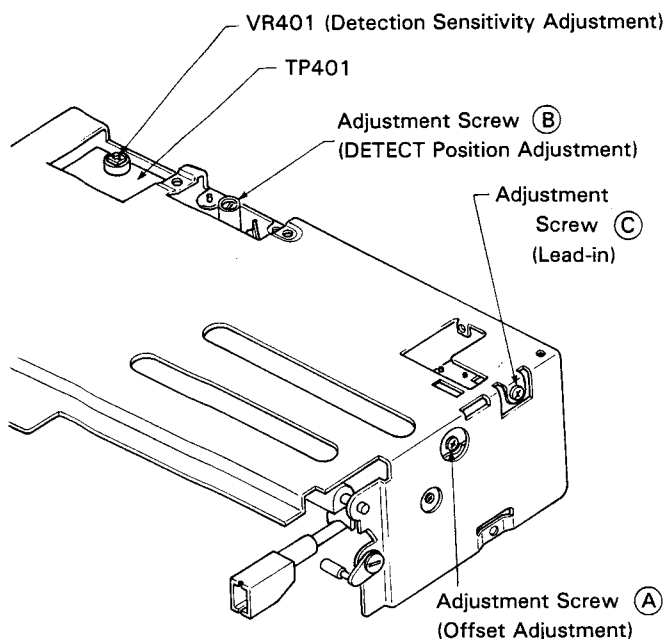

Fig. 20

12-(1) Lead-In Adjustment

Adjust the adjustment screw (C) for a lead-in count of 23 ± 2 for 30-cm records. Check also the lead-out position for 17-cm records.

	Test Record	Count	—
30-cm Lead-In	RG325	23 ± 2	Adjustment
17-cm Lead-In	SS-4445	23 ± 5	Check
17-cm Lead-Out	SS-4445	26 ± 4	Check

12-(2) Offset Adjustment

1. Connect TP203 to ground via a 2.2kΩ resistor, as shown in Fig. 21.
2. Set the tonearm to the UP position.
3. Adjust screw (A) to obtain a voltage of $85 \pm 5_{-10}$ mV between TP201 and TP202.

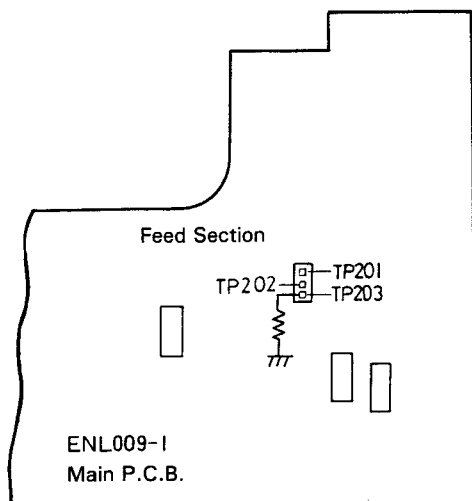

Fig. 21

12-(3) Track Interval (Marker Space) Detection Sensor Sensitivity Adjustment

1. Move the sensor to a position above the reflective ring on the inner circumference of the platter mat by the "<" button.
2. Adjust VR401 to obtain a voltage of $2.1 \text{ V} \pm 0.05 \text{ V}$ between TP401 and ground (0 V).

Note: As the sensor sensitivity is strongly influenced by external light, reduce ambient lighting as much as possible when performing this adjustment.

12-(4) Detect Position (Touch-Down Position) Adjustment

Turn the adjustment screw (B) to the left (↶) or right (↷).

- Note:**
- Correct position adjustment will be possible within about one revolution of the screw. Do not turn the screw excessively.
 - After adjusting screw (B), slide the platter out and in again, cause the tonearm to perform search, and then check the touch-down position. If the search operation is not performed, the touch-down position will not change even if the adjustment screw was turned.

13. Connection Diagram

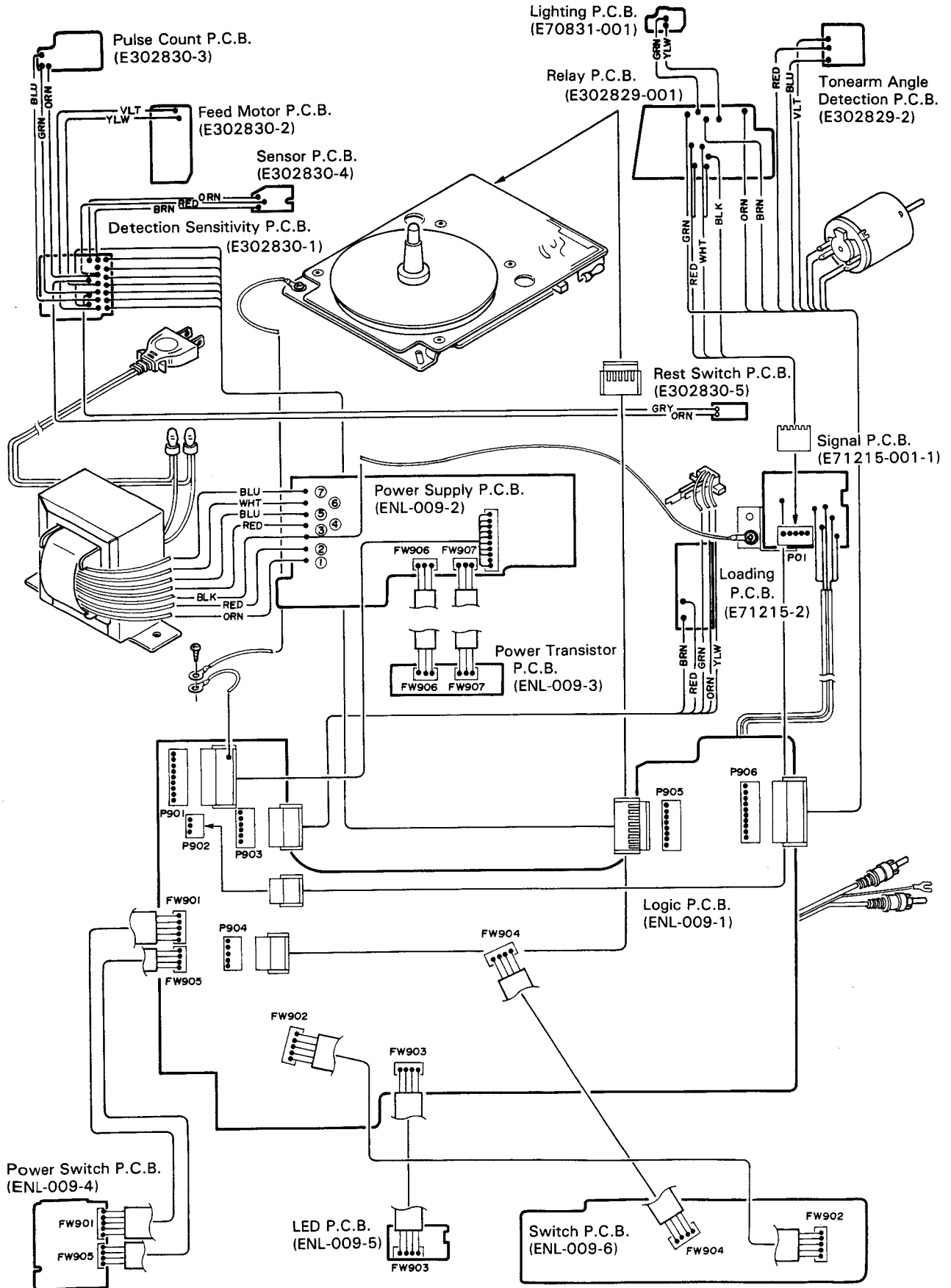
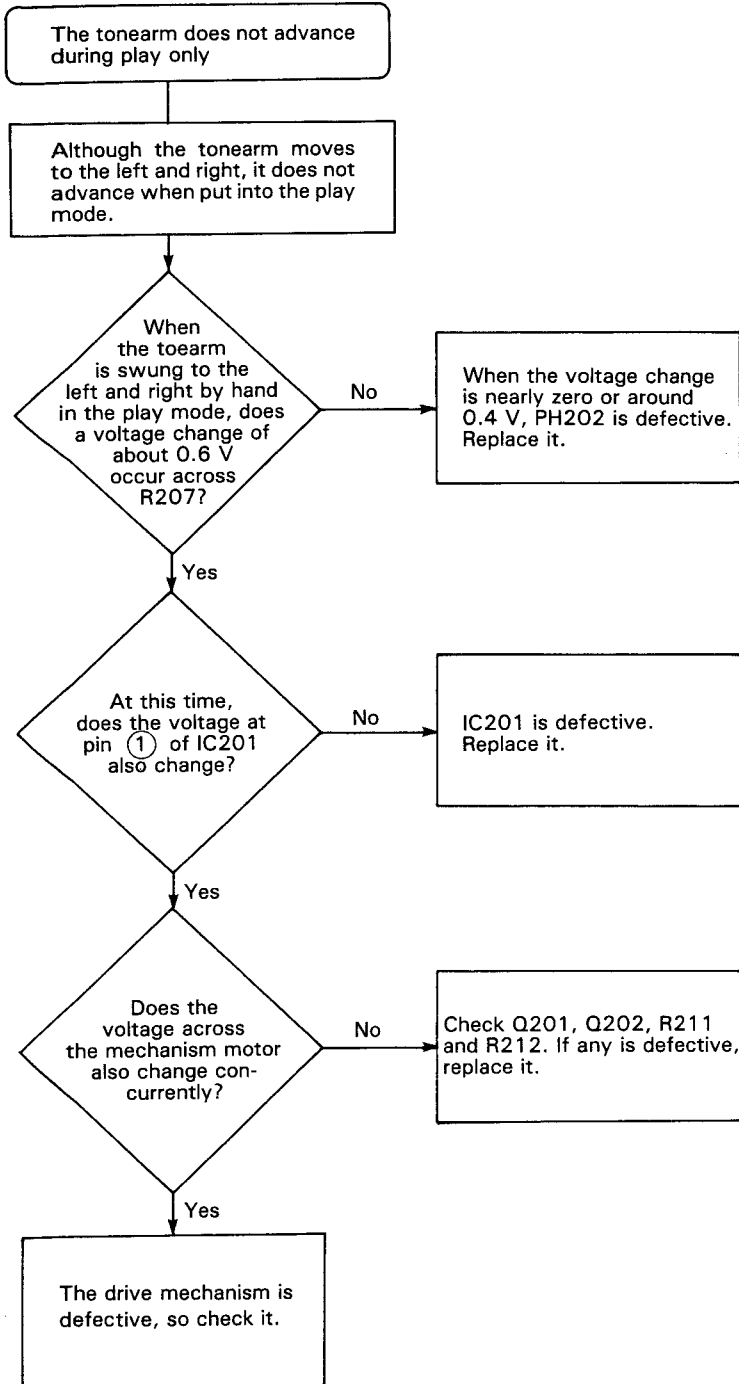
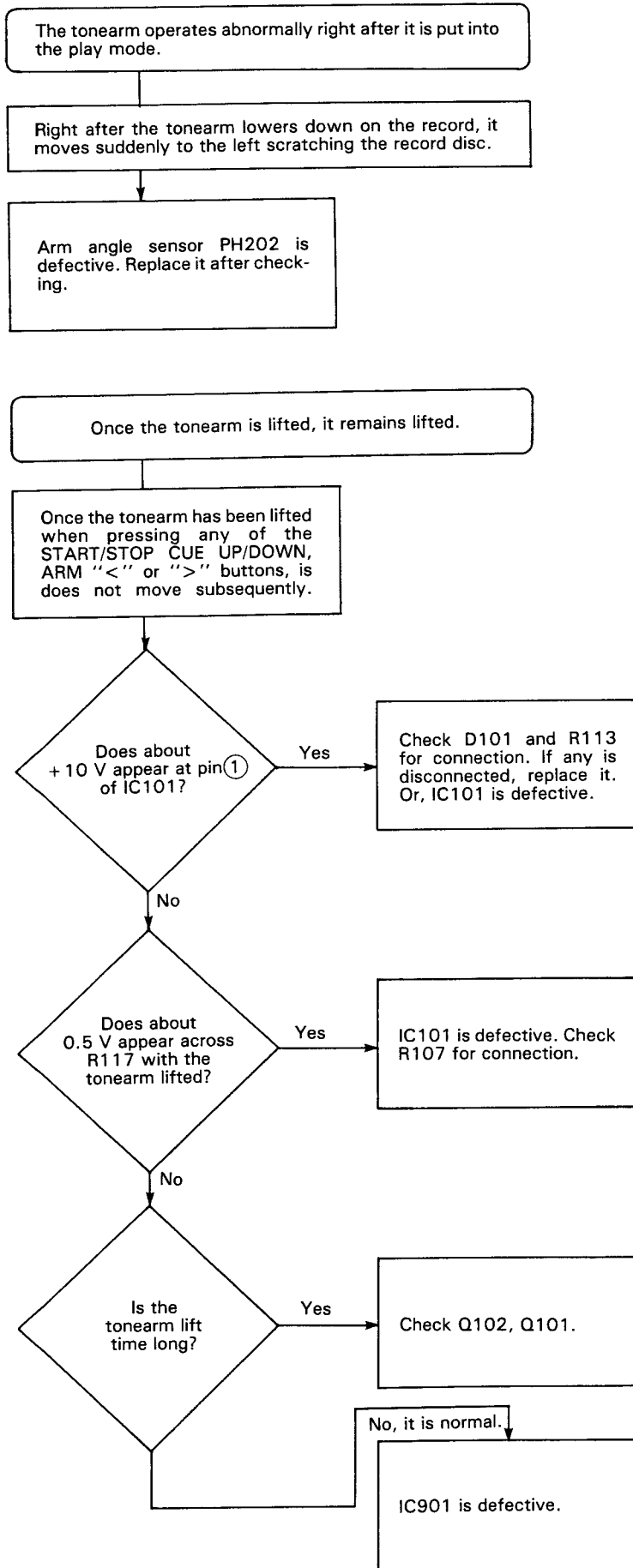

Fig. 22

14. Troubleshooting

14-(1) When Tonearm Action is Abnormal





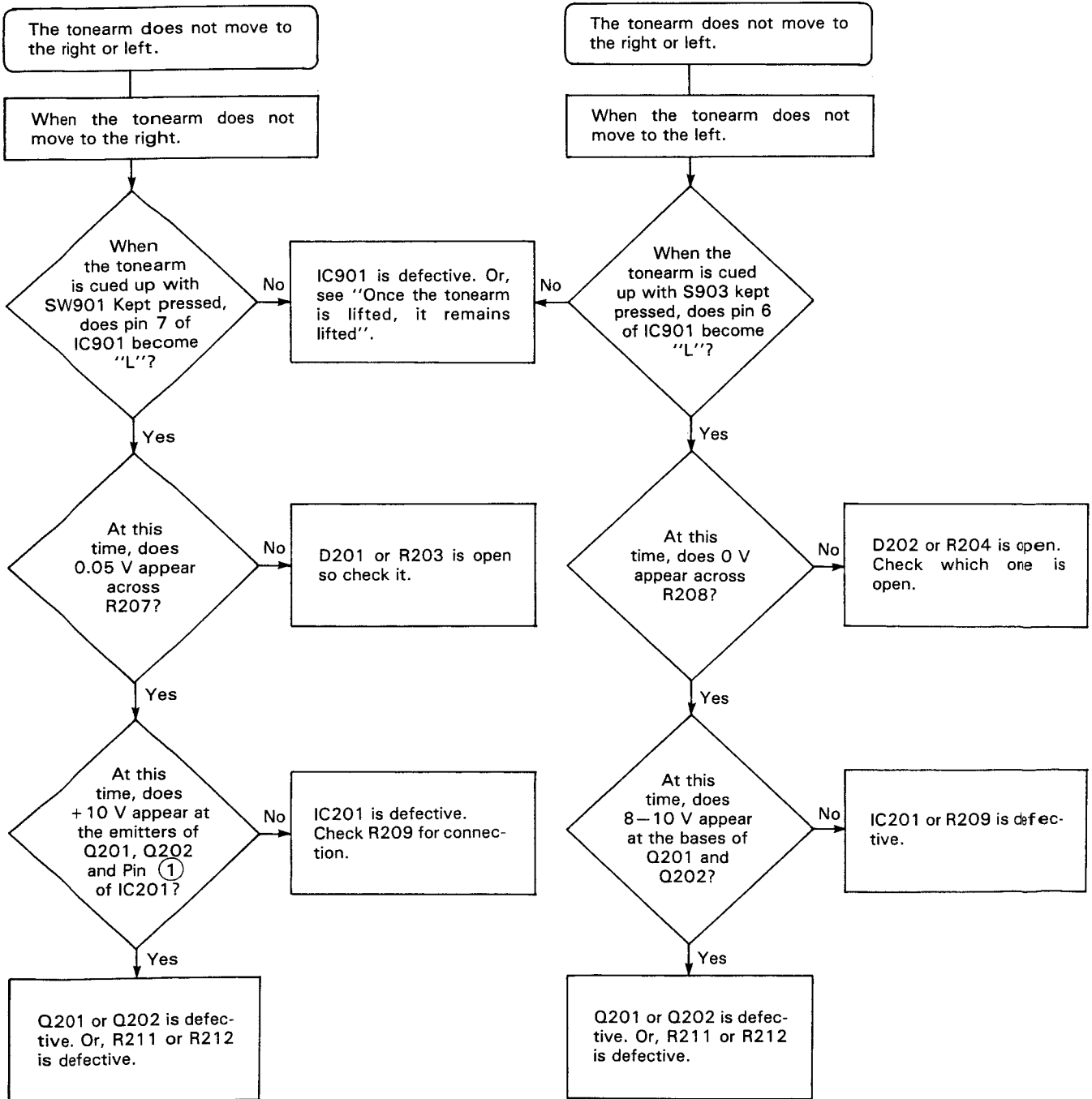

14-(2) When Turntable Operation is Abnormal

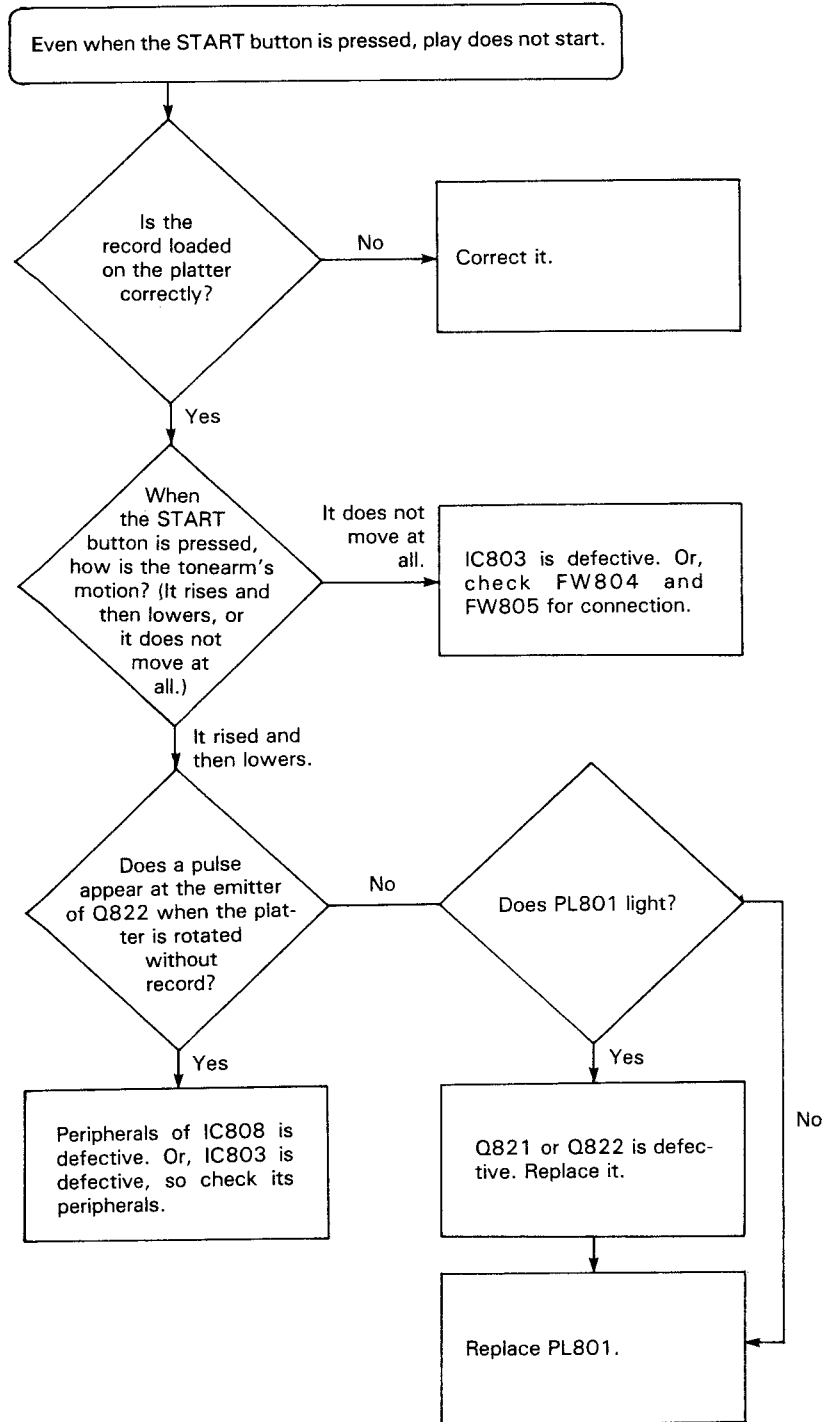

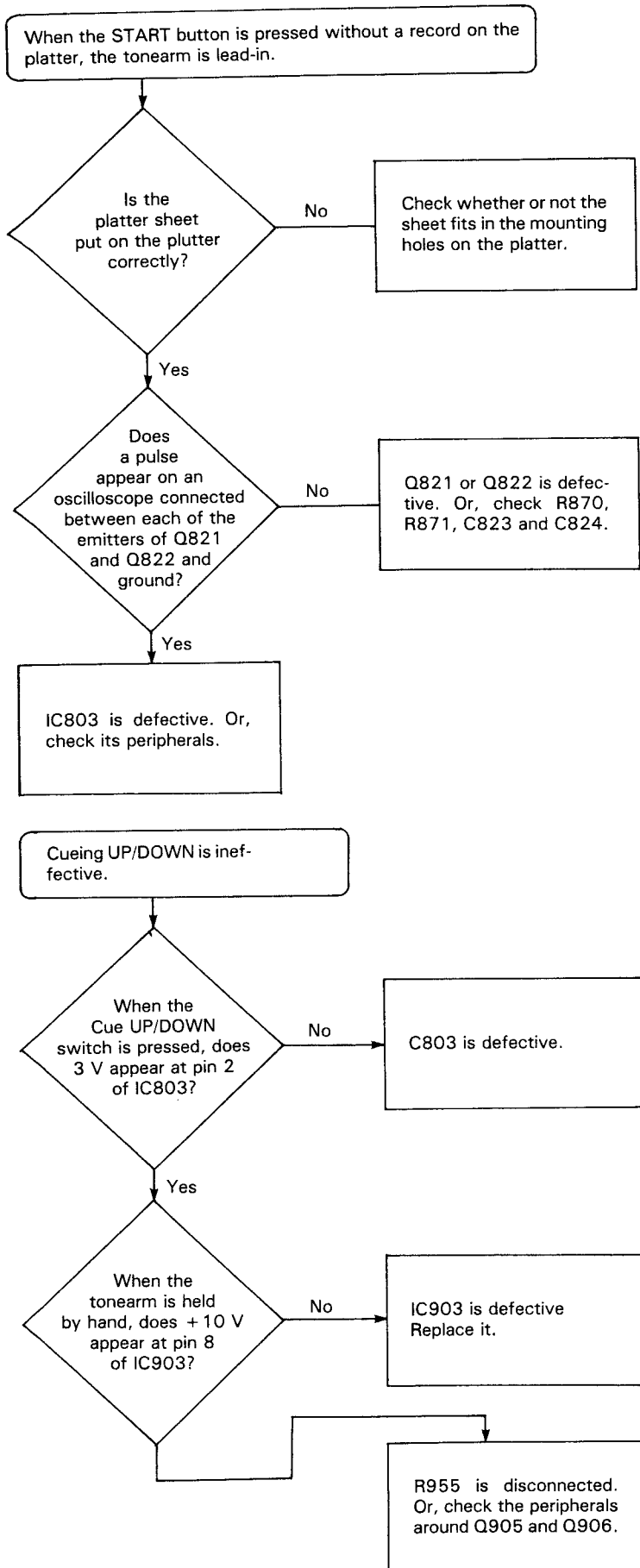

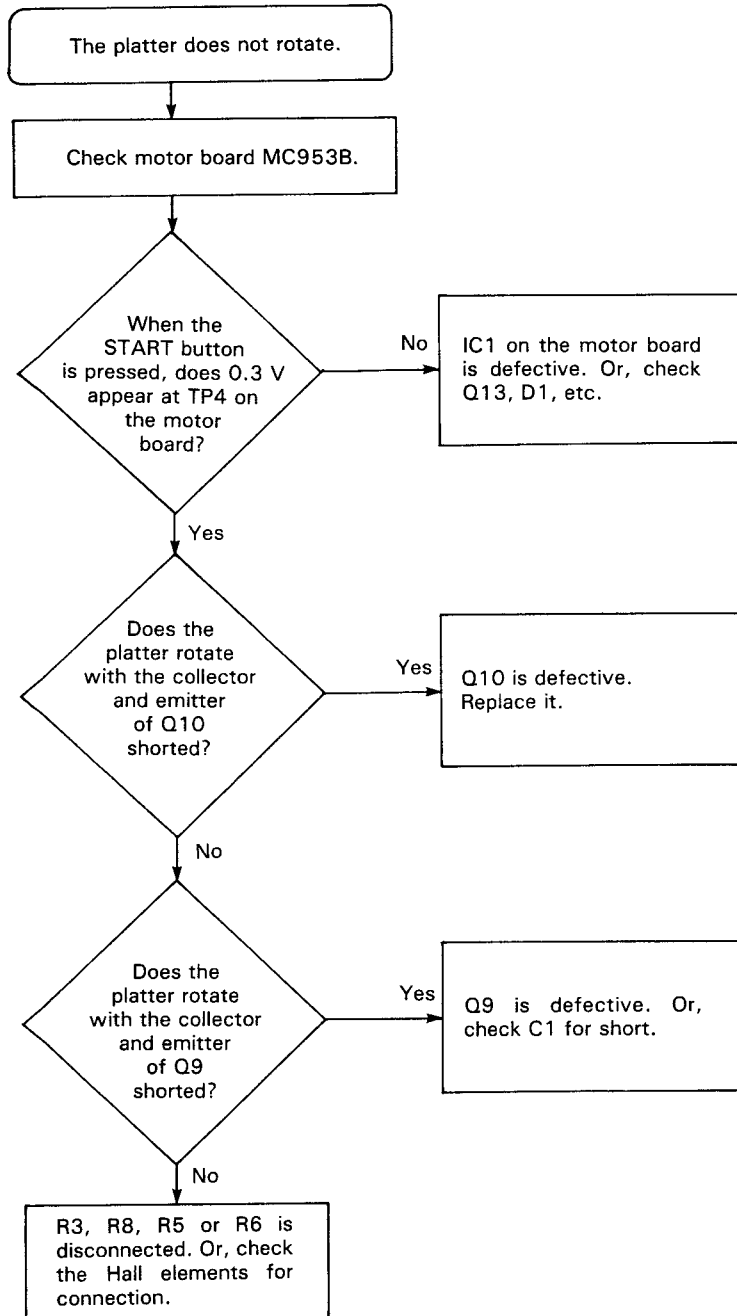

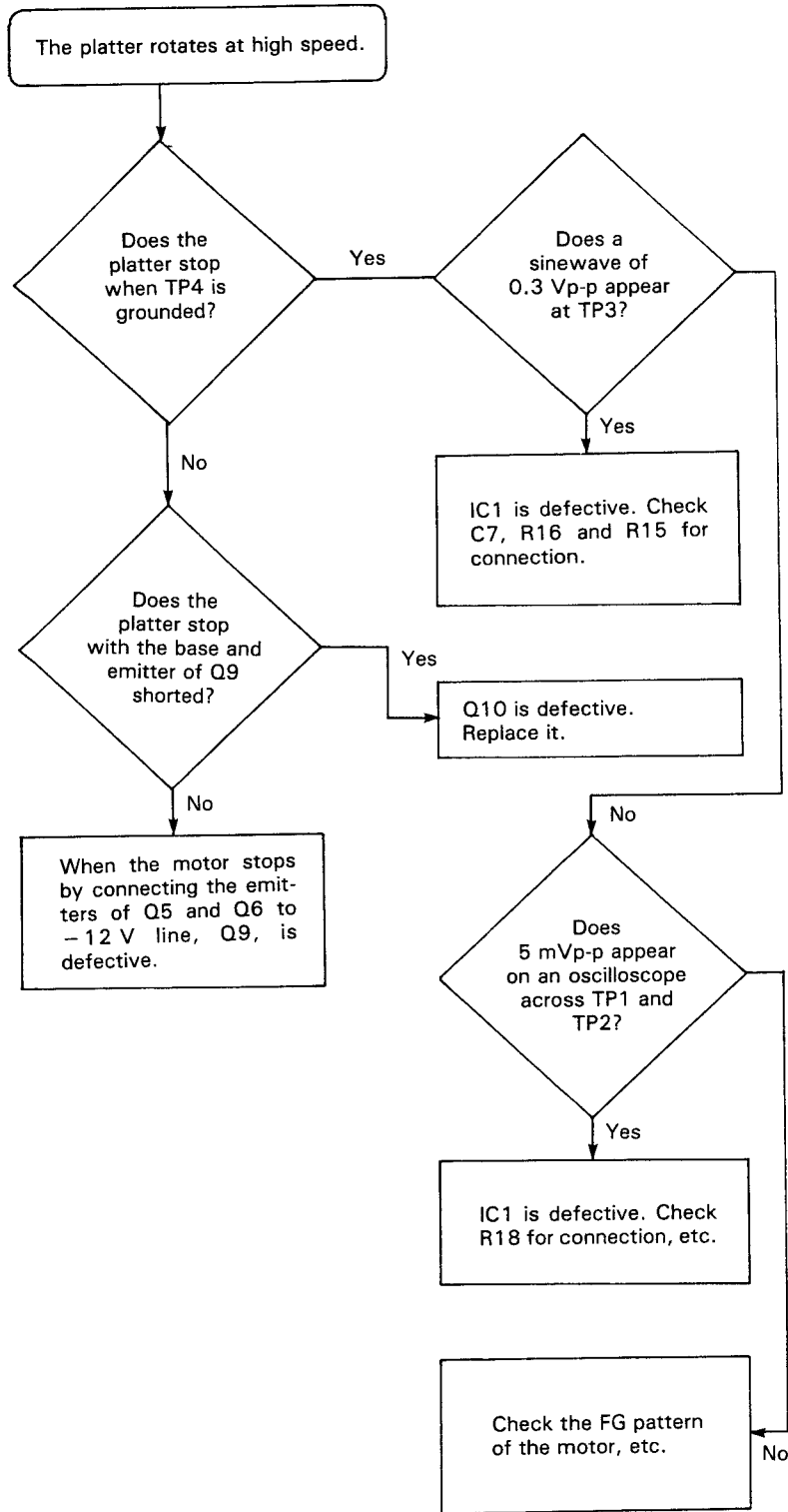

14-(3) When Music Scan Operation is Abnormal

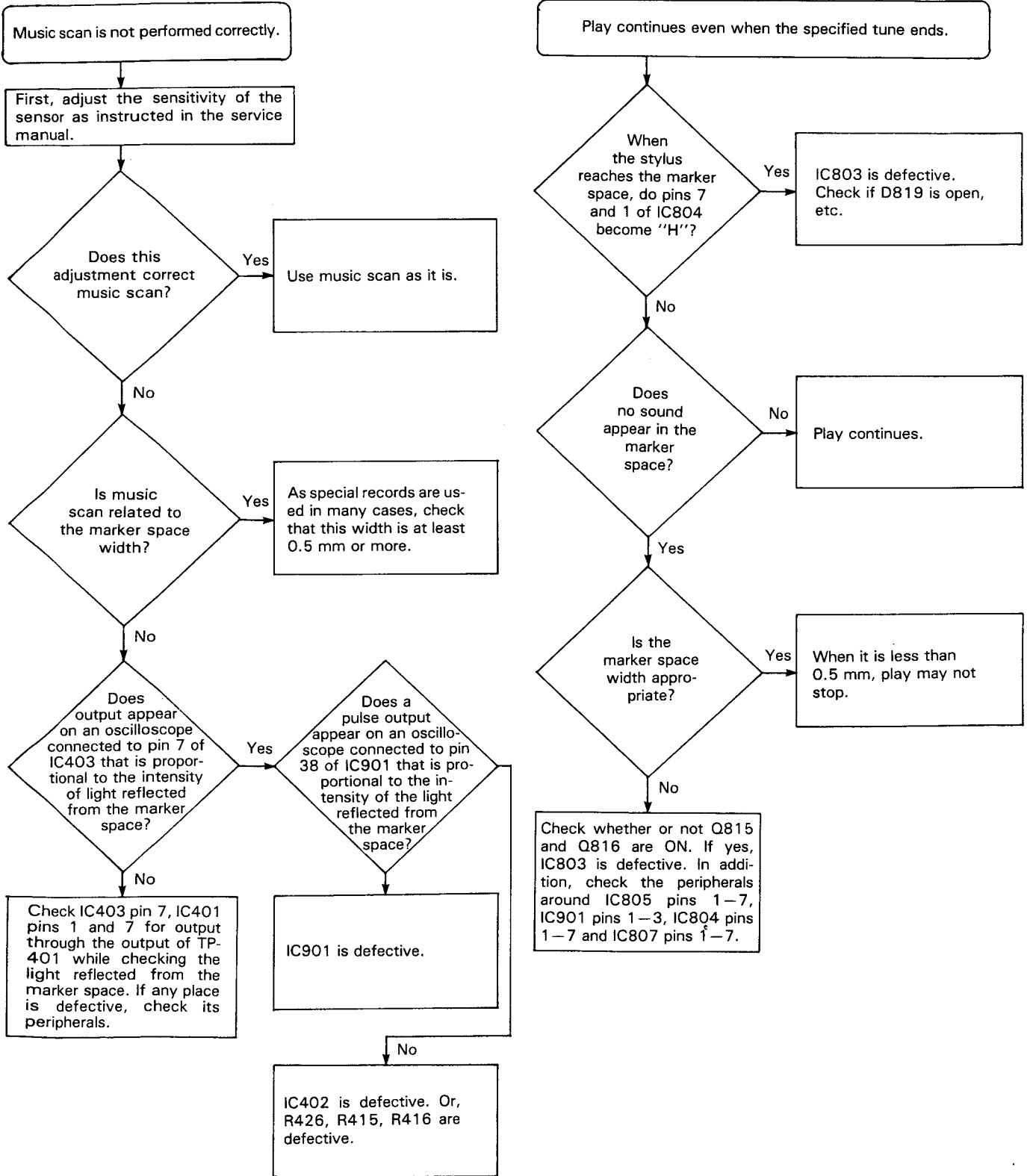

15. Standard Circuit Diagram

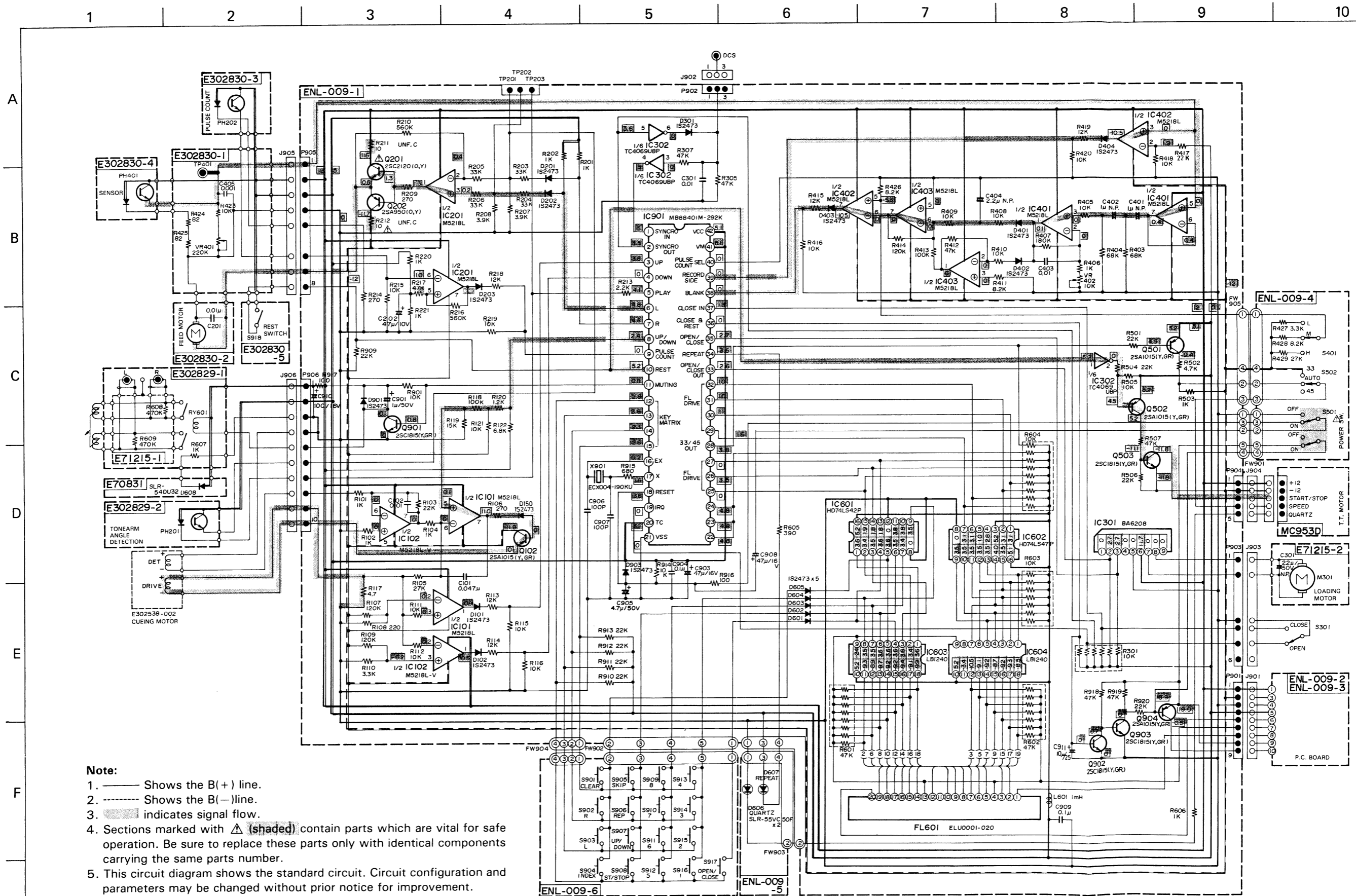

- Note:**
1. ——— Shows the B(+) line.
 2. - - - - - Shows the B(-)line.
 3. [Shaded box] indicates signal flow.
 4. Sections marked with **△** (shaded) contain parts which are vital for safe operation. Be sure to replace these parts only with identical components carrying the same parts number.
 5. This circuit diagram shows the standard circuit. Circuit configuration and parameters may be changed without prior notice for improvement.

Fig. 23

1 2 3 4 5 6 7 8 9 10

A

B

C

D

E

F

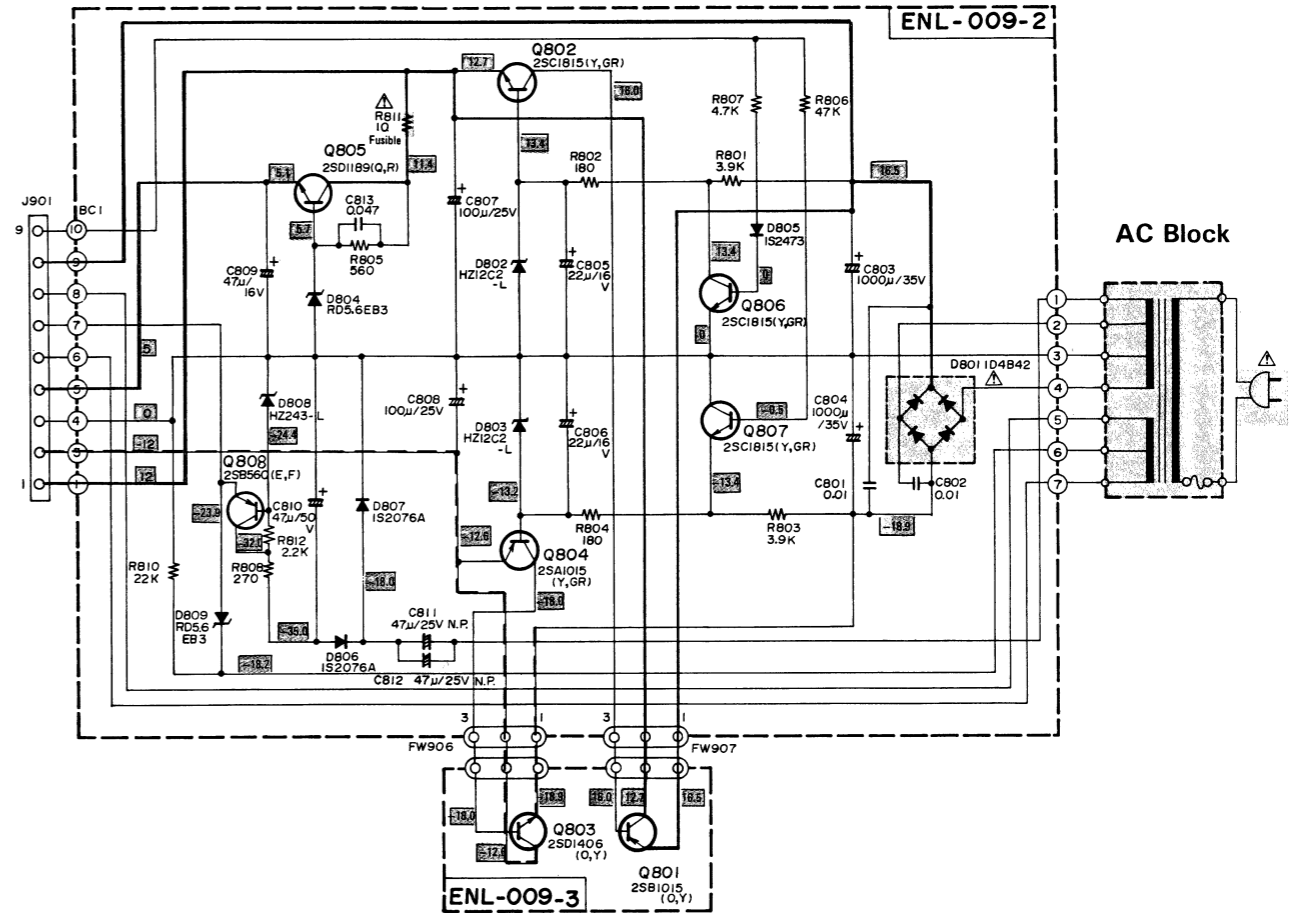
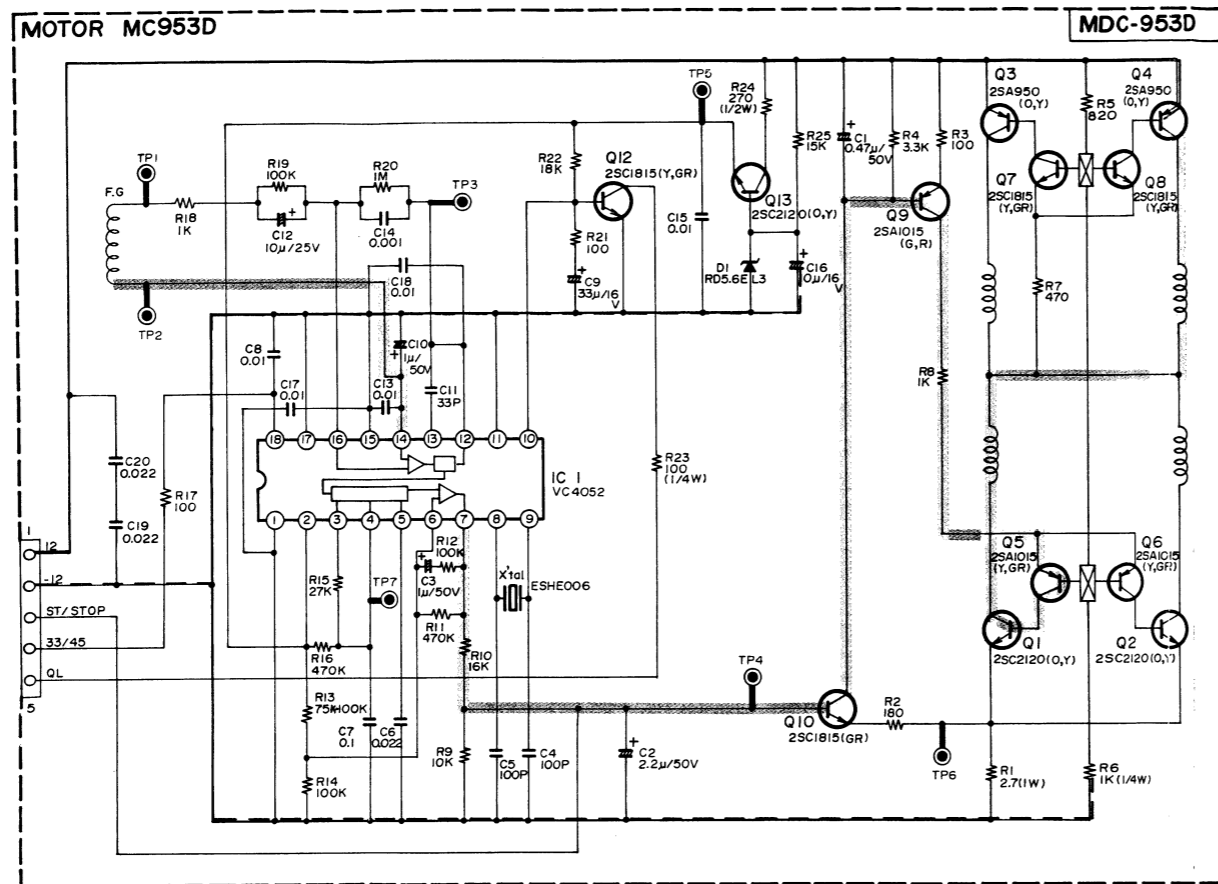

E & G (for Europe & Germany)

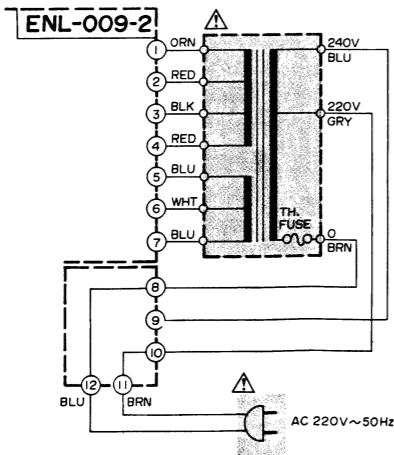

BS (for U.K.)

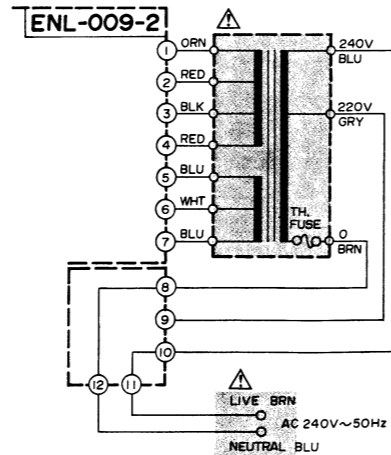

P & U (for U.S. Military Market & Other areas)

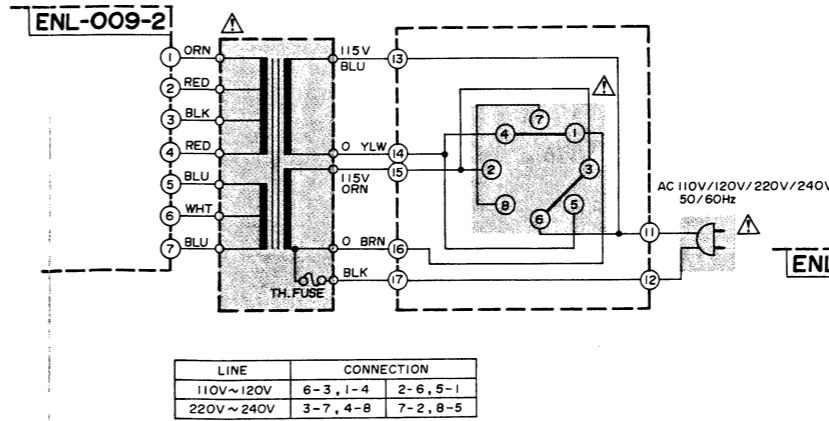

J & C (for USA & Canada)

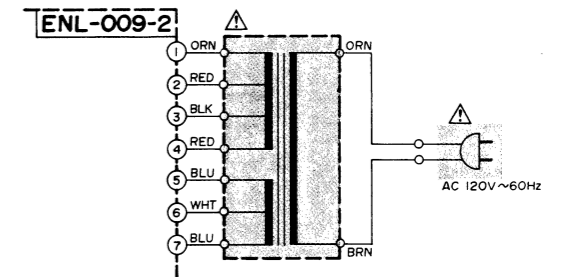

A (for Australia)

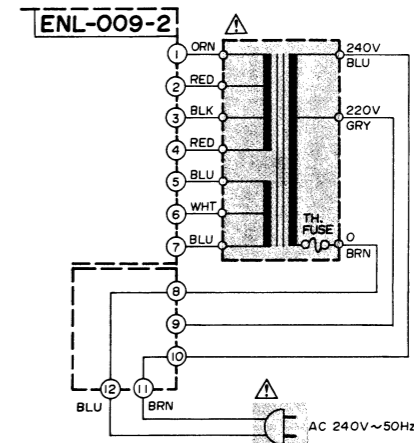

Fig. 24

PARTS LIST

Contents

Main Parts Location	2-2
Exploded View and Parts Numbers	2-3
Exploded View of Mechanism and Parts Numbers	2-9
Printed Circuit Board Ass'y and Parts List	2-11
• ENL-009□ Main P.C. Board Ass'y	2-14
• MC953D Motor Drive P.C. Board Ass'y	2-15
• Muting P.C. Board Ass'y	2-15
• Sensor P.C. Board Ass'y	2-15
• Signal P.C. Board Ass'y	2-16
Packing Materials and Part Numbers	2-18
Accessories List	2-18

Main Parts Location

Front View

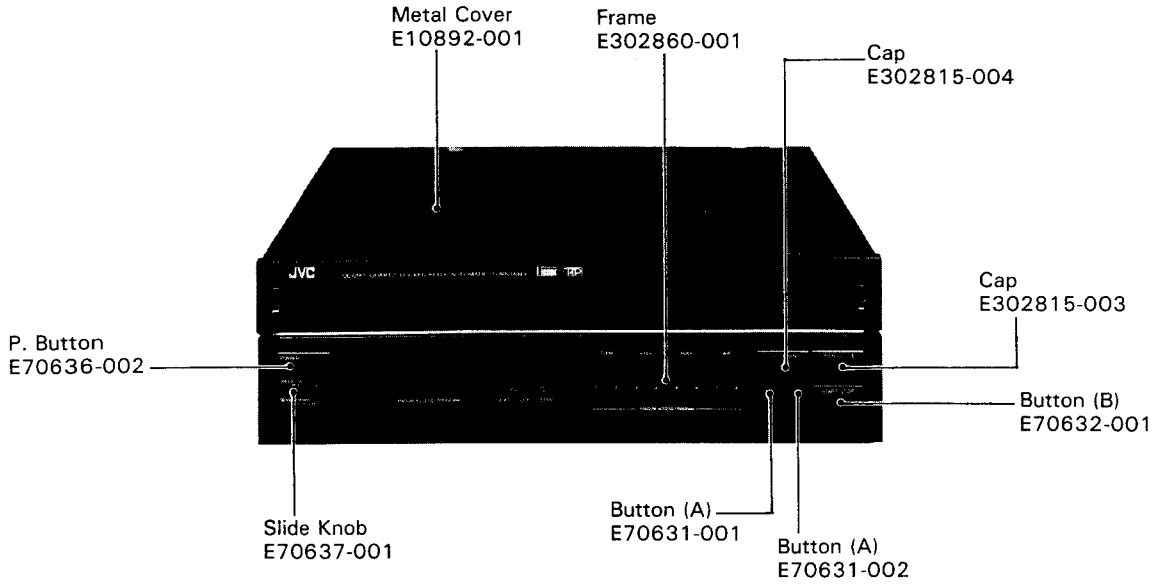

Fig. 1

Top View

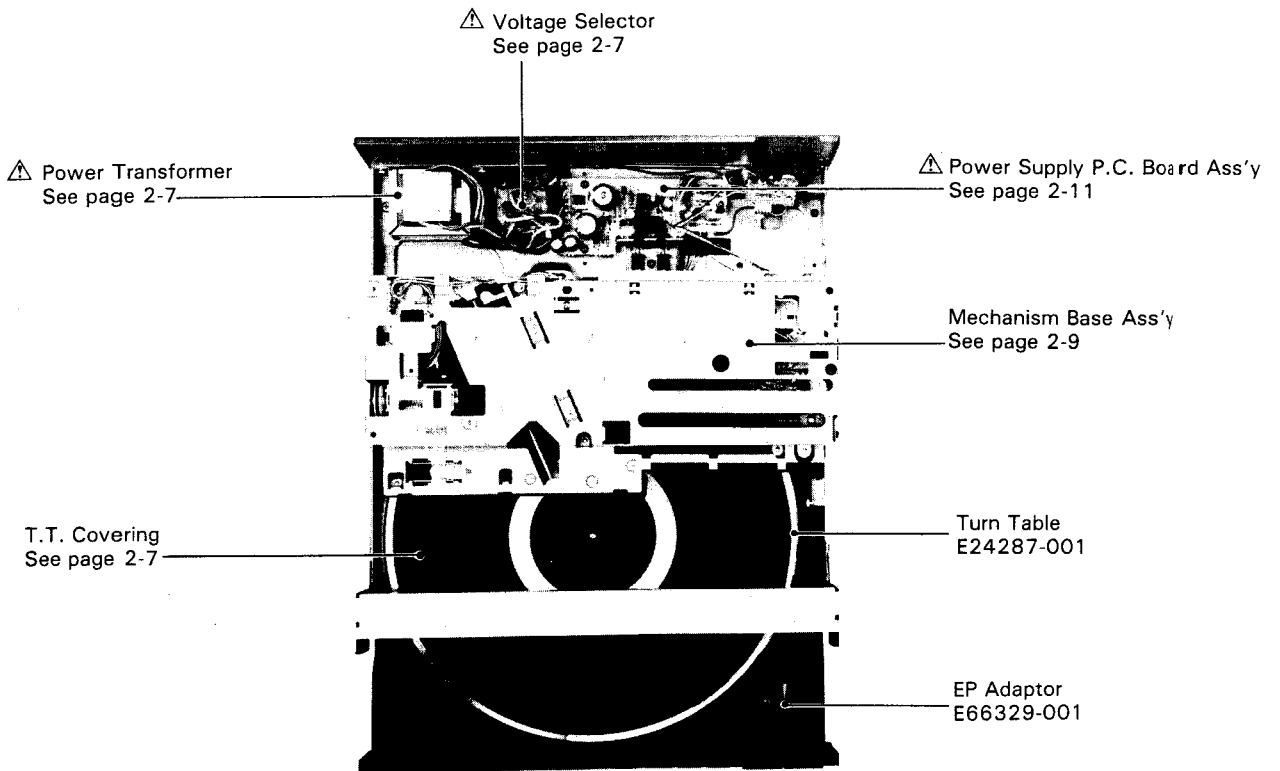

Fig. 2

⚠ : Safety Parts

Exploded View and Part Numbers

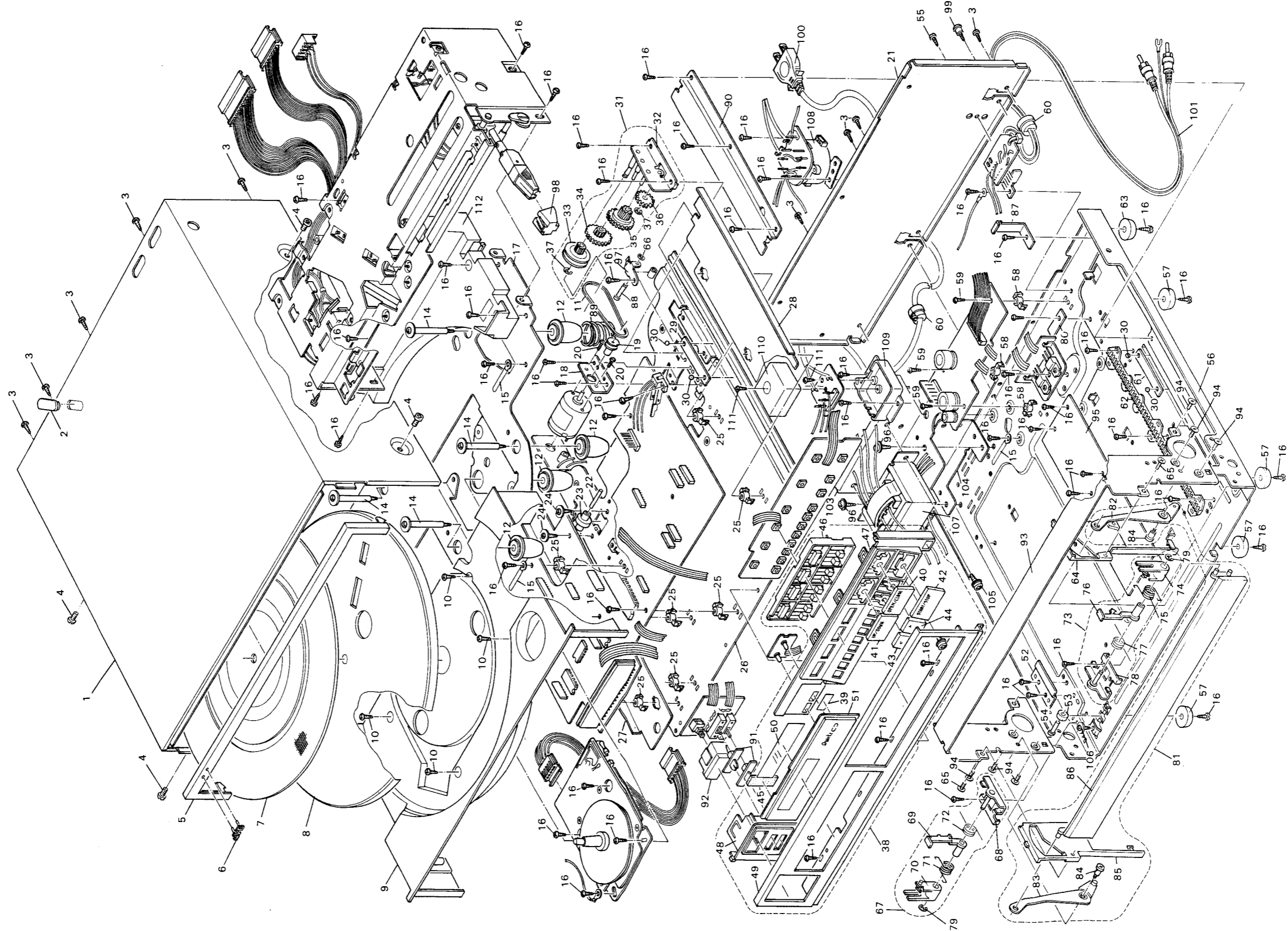

Fig. 3

QL-G90B

QL-G90B

■ U.S.A. and Canada only

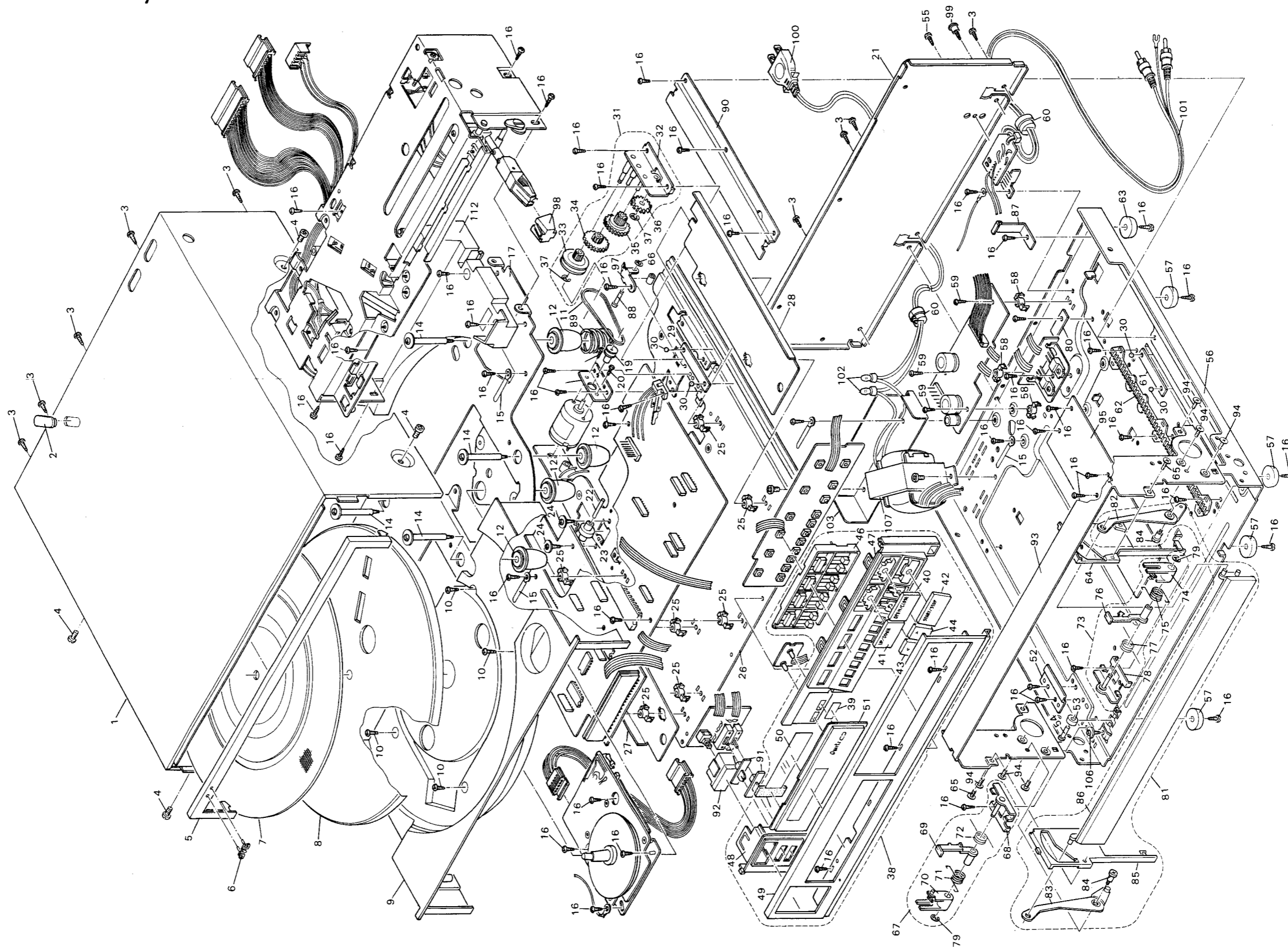

Fig. 4

(No. 2717) 2-5

2-6 (No. 2717)

The Marks for Designated Areas.

J	U.S.A.	A	Australia
C	Canada	P,PG	U.S.Military Market
E	Europe	BS	U.K.
G	West Germany	U	Other Countries
ES	Spain		

No mark indicates all areas.

No.	Part Number	Part Name	Q'ty	Description	Area
1	E10892-001	Top Cover	1	Sensor Side	
2	E71090-001	Cap	2		
3	SBSB3006M	Tapping Screw	9		
4	E61660-004	Special Screw	4		
5	E24487-001	Door Cover	1		
6	E70912-001	JVC Mark	1		J,C Except J,C
7	E302859-001	T.T. Covering Ass'y	1		
8	E302859-002	T.T. Covering Ass'y	1		
9	E24287-001	Turn Table	1		
	E10897-001	Cabinet	1		J,C
10	E10897-002	Cabinet	1		
11	SBST3018Z	Tapping Screw	4		
12	E69879-001	Belt	1		
14	E70624-001	F. Rubber	4		
	E70593-001	Special Screw	4		
15	E50670-005	Wire Clamp	1		
16	SBST3006Z	Tapping Screw	57		
17	E24483-004	T.T. Base	1		
18	E70595-001	Motor Bracket	1		
19	E67824-004	Pulley	1		
20	SPSP2003Z	Screw	2		
21	E24482-003	Rear Panel	1		
22	E70844-001	Shaft	1		
23	E71087-001	Loading Roller	1		
24	E70845-001	Special Screw	2		
25	E70585-001	C. Board Holder	7		
26	E10894-003	Loading Base	1		
27	E71091-001	Cover (L)	1		
28	E71092-002	Cover (R)	1		
29	E71084-001	Ball Holder	1		
30	G41505-5	Steel Ball	4		
31	E302840-003	Gear Ass'y	1		
32	E302841-002	Gear Base Ass'y	1		
33	E302848-001	Pulley	1		
34	E302846-001	Gear (A)	1		
35	E302847-001	Gear (B)	1		J,C Except J,C
36	E70611-001	Gear (C)	1		
37	REE3000X	E. Ring	2		
38	E24488-002	Front Panel	1		
	E24488-001	Front Panel	1		
39	E71174-001	Sheet	1	OPEN/CLOSE UP/DOWN START/STOP L	
40	E302815-003	Cap	1		
41	E302815-004	Cap	1		
42	E70632-001	Button (B)	1		
43	E70631-001	Button (A)	1		
44	E70631-002	Button (A)	1	R	
45	EX0030008N30S	Felt Spacer	1		
46	E302860-001	Frame	1		
47	E24523-001	Escutcheon (R)	1		
48	E302926-002	Escutcheon (L)	1		
49	E302926-001	Escutcheon (L)	1		Except J,C
50	E302928-001	Front Panel	1		
51	E70634-001	Filter	1		
52	E302927-001	Window	1		
	E70586-001	Bracket	1		

△ : Safety parts

No.	Part Number	Part Name	Q'ty	Description	Area
53	E70589-001	Rollar	1		
54	E70590-002	Shaft	1		
55	SBSB3008M	Tapping Screw	1		
56	E10893-002	Bottom Board	1		
57	E47227-021	Foot	4		
58	E70585-002	C. Board Holder	3		Except J,C
	E70585-003	C. Board Holder	3		J,C
59	SBST3012Z	Tapping Screw	7		
△ 60	QHS3876-162	Cord Stopper	2		Except BS
	QHS3876-162BS	Cord Stopper	2		BS
61	E71083-002	Ball Holder	1		
62	E302844-001	Rack	1		
63	E47227-022	Foot	2		
64	E302941-002	Cam	1	R	
65	SSSB2606M	Screw	2		
66	REE2000X	E. Ring			
67	E303182-001	Lever Base Ass'y	1	L	
68	E71085-001	L. Base Sub Ass'y	1		
69	E302858-001	Lever (A)	1		
70	E70592-001	Lever (B)	1		
71	E70629-001	Spring (A)	1		
72	E70630-001	Spring (B)	1		
73	E303182-002	Lever Base Ass'y	1	R	
74	E70592-002	Lever (B)	1		
75	E70629-002	Spring (A)			
76	E302858-002	Lever (A)			
77	E70630-001	Spring (B)	1		
78	E71085-001	L. Base Sub Ass'y	1		
79	REE3000X	E. Ring	2		
80	E71162-001	Wire Plate	1		
81	E24484-002	Door Ass'y	1		
82	E302857-002	Door Lever	1	R	
83	E302857-001	Door Lever	1	L	
84	E70628-001	Special Screw	2		
85	E302941-001	Cam	1	L	
86	E24486-002	Door	1		
87	E71220-001	Stopper	1		
88	E71218-001	Roller Shaft	1		
89	E71294-001	Spring	1		
90	E302843-001	Ball Holder	1		
91	E70637-001	Slide Knob	2		
92	E70636-002	Power Button	1		
93	E10896-001	Door Base	1		
94	SSST3006M	Tapping Screw	6		
95	E71161-001	Sheet	1		
96	E60134-001	Special Screw	2		
97	E71217-001	Roller Bracket	1		
98	E70328-002	Stylus Cover	1		
99	E66052-001	Special Screw	1		
△ 100	QMP1200-200	Power Cord	1		J,C
	QMP7600-250	Power Cord	1		U,P,PG
	QMP3900-200	Power Cord	1		E,G,ES
	QMP2560-244	Power Cord	1		A
	QMP9017-008BS	Power Cord	1		BS
101	EWP306-001	Signal Cord	1		
△ 102	E03830-001	Connector	1		J,C
103	E71518-001	Cover	1		Except J,C
	E71554-001	Cover	1		J,C
104	E71535-001	Trans. Bracket	1		
105	E60134-001	Special Screw	2		
106	E50670-005	Wire Clamp	2		
△ 107	ETP1010-17JA	Power Transformer	1		J,C
	ETP1010-17ZA	Power Transformer	1		U,P,PG
	ETP1010-17EA	Power Transformer	1		E,A,G,ES
	ETP1010-17EABS	Power Transformer	1		BS
△ 108	QSR0085-007	Voltage Selector	1		U,P,PG
△ 109	E303428-001	Primary Case	1		E,A,G,BS,ES
△ 110	E303429-001	Primary Cover	1		E,A,G,BS,ES
111	SBSF3008Z	Tapping Screw	1		E,A,G,BS,ES
112	E10907-001	Base Joint	1		Except J
	E10907-002	Base Joint	1		J

Exploded View of Mechanism

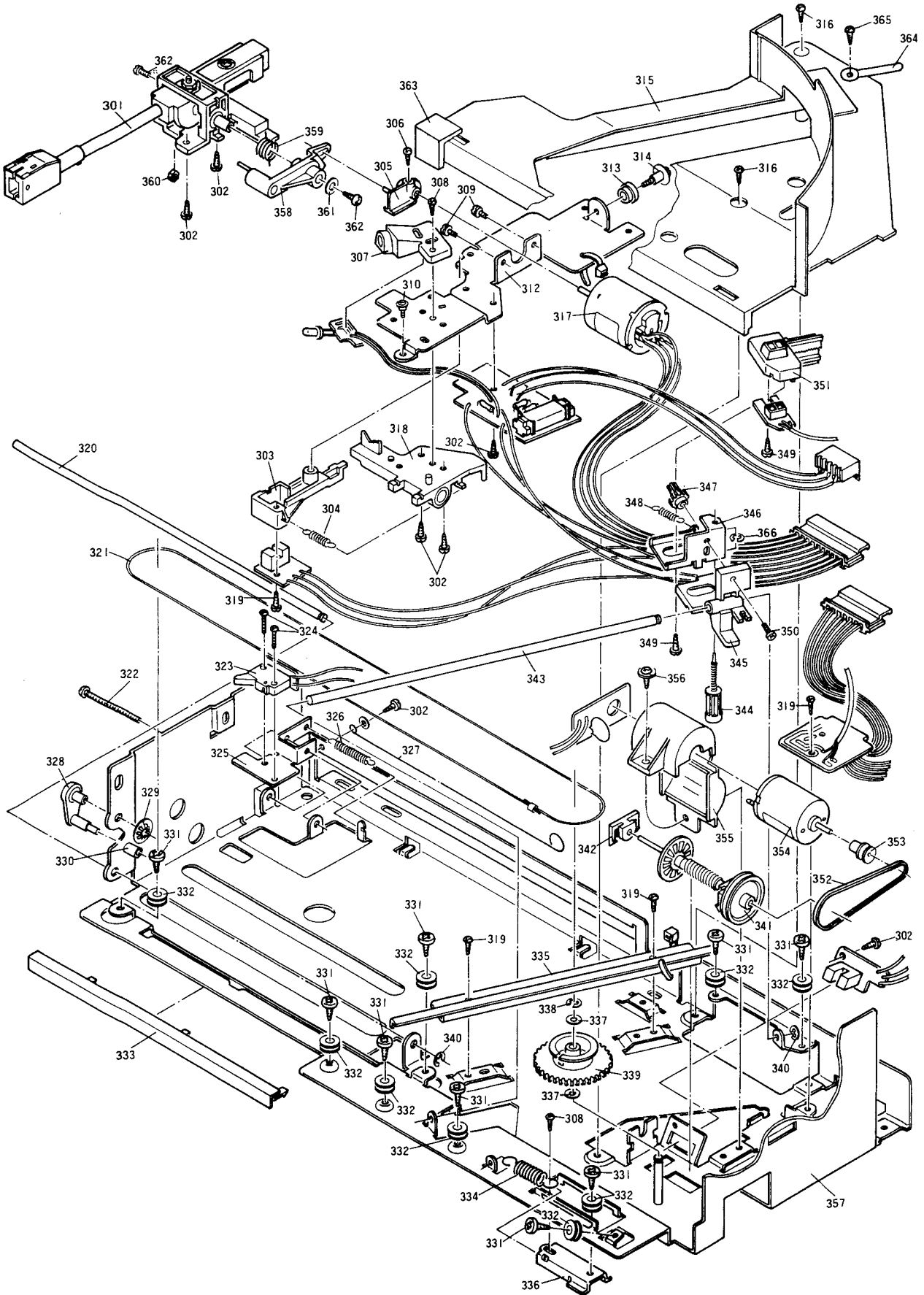

Fig. 5

Mechanism Ass'y List

Item	Part Number	Part Name	Q'ty	Description
301	E24524-001	Tonearm Ass'y	1	
302	SBST3006Z	Screw	5	
303	E302897-001	Lever	1	
304	E70604-001	Spring	1	
305	E70601-001	Cueing Lever (A)	1	
306	SPSP3006Z	Screw	1	
307	E70625-001	LED Holder	1	
308	SBST3008Z	Screw	1	
309	LPSP3005Z	"	2	
310	DBST3006Z	"	1	
312	E302849-002	Arm Base	1	
313	E70602-001	Roller	1	
314	E69851-001	Screw	1	
315	E24481-003	M. Cover (A)	1	
316	SBST3018Z	Screw	2	
317	E302538-002	Motor	1	
318	E70603-002	Hook Ass'y	1	
319	SBSF3006Z	Screw	1	
320	E70607-001	Arm Shaft	1	
321	E70623-002	Rope Ass'y	1	
322	SPSP3035M	Screw	1	
323	QSS1201-034	Slide Switch	1	
324	SPSP2008Z	Screw	2	
325	E70608-001	Switch Bracket	1	
326	E70609-001	Spring	1	
327	E71089-001	"	1	
328	E70605-001	Lever	1	
329	E70007-001	Speed Nut	1	
330	E70267-002	Rubber Tube	4	
331	E70620-001	Screw	8	
332	E70619-001	Roller	9	
333	E70633-001	M. Cover (B)	1	
334	E70622-001	Spring	1	
335	E70616-001	Bracket	1	
336	E70621-002	Roller Bracket	1	
337	Q03093-817	Spacer	2	
338	REE3000X	E Ring	1	
339	E302855-001	Warm Wheel	1	
340	REE2500X	E Ring	2	
341	E302856-001	Warm Ass'y	1	
342	E69875-001	Bearing Stand	1	
343	E70610-001	Shaft (B)	1	
344	E70613-001	Warm	1	
345	E302852-001	Holder	1	
346	E302853-001	Bracket	1	
347	E70614-001	Gear (S)	1	
348	E70612-001	Spring	1	
349	SBSB2605Z	Screw	2	
350	LPSP2606Z	"	1	
351	E302851-001	Case	1	
352	E69879-001	Belt	1	
353	E67824-004	Pully	1	
354	E300763-005	Motor	1	
355	E302854-001	Motor Holder	1	
356	E69851-004	Screw	1	
357	E10895-001	Mechanism Base Sub Ass'y	1	
358	E302863-001	Cueing Lever (B)	1	
359	E70645-001	Spring	1	
360	NTB2600	Nut	1	
361	E67605-001	Washer	1	
362	SPSP2608Z	Screw	1	
363	EXO025012N10S	Spacer	1	
364	E50670-005	Wire Clamp	1	
365	SBSF3006Z	Screw	1	
366	E71331-001	E Ring	1	

Printed Circuit Board Ass'y and Parts List

ENL-009 □ Main P.C. Board Ass'y

Note: ENL-009 □ varies according to the areas employed. See note (1) when replacing an order.

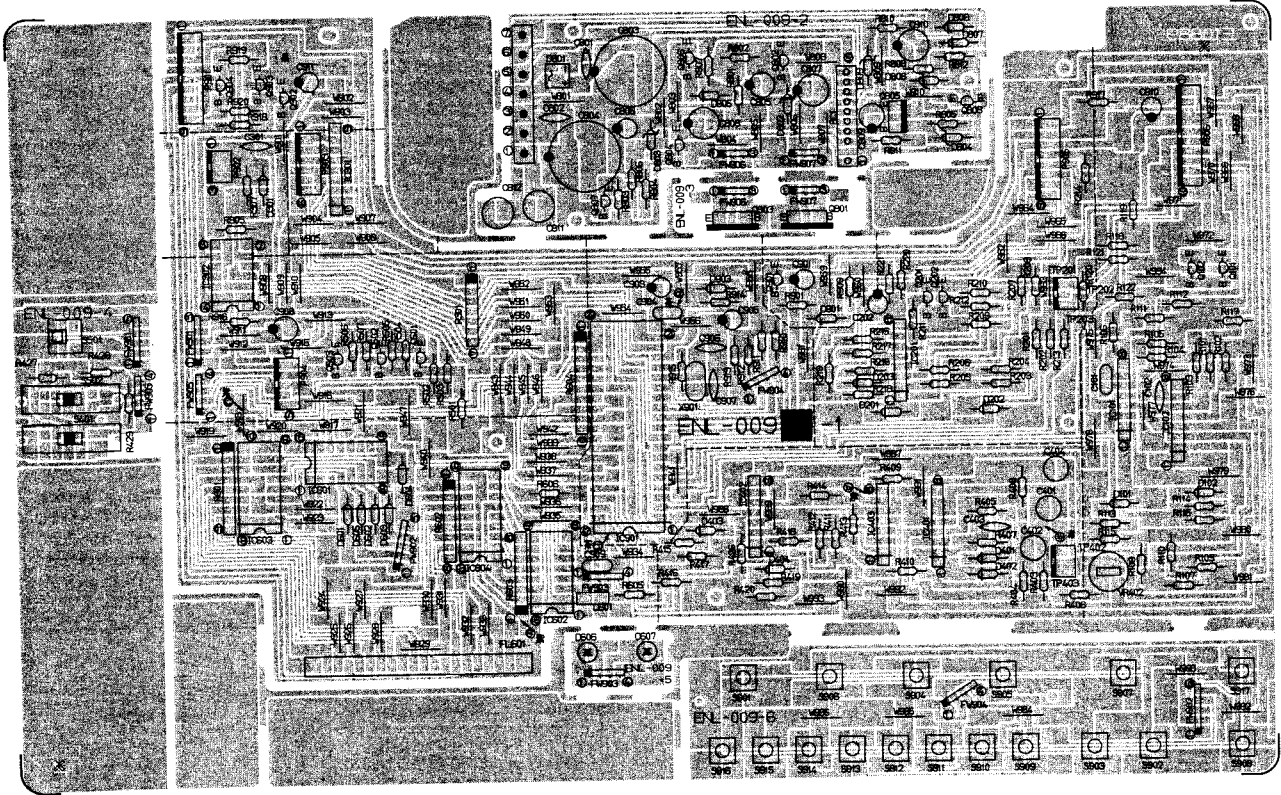

Fig. 6

Note (1)

Designated Areas	P.C. Board Ass'y
U.S.A., Canada	ENL-009 D
Europe, Australia, U.S. Military Market Other Countries	ENL-009 B
U.K.	ENL-009 E

Note (2)

The symbols (赤, 黒, 白.....etc.) on P.C. Board surface are factory process only.

Each Individual P.C. Board Location

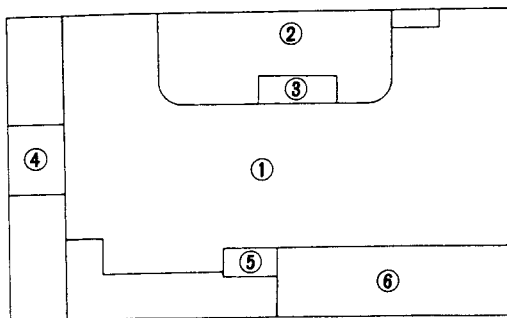

Fig. 7

- ① ENL-009-1 Main P.C. Board Ass'y
- ② ENL-009-2 Power Supply P.C. Board Ass'y
- ③ ENL-009-3 Power Transistor P.C. Board Ass'y
- ④ ENL-009-4 Power Switch P.C. Board Ass'y
- ⑤ ENL-009-5 Indicator P.C. Board Ass'y
- ⑥ ENL-009-6 Function P.C. Board Ass'y

Transistors

Item No.	Parts Number	Description	
			Maker
Q102	2SA1015(Y,GR)	Silicon	Toshiba
Q201	2SC2120(O,Y)	Silicon	Toshiba
Q202	2SA950(O,Y)	Silicon	Toshiba
Q501	2SA1015(Y,GR)	Silicon	Toshiba
Q502	2SA1015(Y,GR)	Silicon	Toshiba
Q503	2SC1815(Y,GR)	Silicon	Toshiba
Q801	2SB1015(O,Y)	Silicon	Toshiba
Q802	2SC1815(Y,GR)	Silicon	Toshiba
Q803	2SD1406(O,Y)	Silicon	Toshiba
Q804	2SA1015(Y,GR)	Silicon	Toshiba
Q805	2SD1189(Q,R)	Silicon	Rohm
Q806	2SC1815(Y,GR)	Silicon	Toshiba
Q807	2SC1815(Y,GR)	Silicon	Toshiba
Q808	2SB560(E,F)	Silicon	Sanyo
Q901	2SC1815(Y,GR)	Silicon	Toshiba
Q902	2SC1815(Y,GR)	Silicon	Toshiba
Q903	2SC1815(Y,GR)	Silicon	Toshiba
Q904	2SA1015(Y,GR)	Silicon	Toshiba

ICs

Item No.	Parts Number	Description	
			Maker
IC101	M5218L		Mitsubishi
IC102	M5218L-V		Mitsubishi
IC201	M5218L		Mitsubishi
IC301	BA6208		Sanyo
IC302	TC4069UBP		Toshiba
IC401	M5218L		Mitsubishi
IC402	M5218L		Mitsubishi
IC403	M5218L		Mitsubishi
IC601	HD74LS42P		Hitachi
IC602	HD74LS47P		Hitachi
IC603	LB1240		Sanyo
IC604	LB1240		Sanyo
IC901	MB88401M-292K		Fuji

Diodes

Item No.	Parts Number	Description	
			Maker
D101	1S2473	Silicon	Rohm
D102	1S2473	Silicon	Rohm
D150	1S2473	Silicon	Rohm
D201	1S2473	Silicon	Rohm
D202	1S2473	Silicon	Rohm
D203	1S2473	Silicon	Rohm
D301	1S2473	Silicon	Rohm
D401	1S2473	Silicon	Rohm
D402	1S2473	Silicon	Rohm
D403	1S2473	Silicon	Rohm
D404	1S2473	Silicon	Rohm
D601	1S2473	Silicon	Rohm
D602	1S2473	Silicon	Rohm
D603	1S2473	Silicon	Rohm
D604	1S2473	Silicon	Rohm
D605	1S2473	Silicon	Rohm
D606	SLR-55VC50F	L.E.D.	Rohm
D607	SLR-55VC50F	L.E.D.	Rohm
D801	1D4B42	Silicon	Toshiba
D802	HZ12C2-L	Silicon	Hitachi
D803	HZ12C2-L	Silicon	Hitachi
D804	RD5.6EB3	Zener	NEC
D805	1S2473	Silicon	Rohm
D806	1S2076A	Silicon	Hitachi
D807	1S2076A	Silicon	Hitachi
D808	HZ24-3L	Zener	Hitachi
D809	RD5.6EB3	Zener	NEC
D901	1S2473	Silicon	Rohm
D903	1S2473	Silicon	Rohm

Capacitor

Item No.	Parts Number	Description		
C101	QFV71HJ-473	0.047 MF	50 V	T. Film
C102	QCF31HP-103	0.01 MF	50 V	Ceramic
C202	QET61AM-476	47 MF	10 V	Electrolytic
C301	QCF31HP-103	0.01 MF	50 V	Ceramic
C401	QEN61HM-105	1 MF	50 V	Non Pole
C402	QEN61HM-105	1 MF	50 V	Non Pole
C403	QCF31HP-103	0.01 MF	50 V	Ceramic
C404	QEN61HM-225	2.2 MF	50 V	Non Pole
C801	QCF31HP-103	0.01 MF	50 V	Ceramic
C802	QCF31HP-103	0.01 MF	35 V	Ceramic
C803	QEU51VM-108	1000 MF	35 V	Electrolytic
C804	QEU51VM-108	1000 MF	35 V	Electrolytic
C805	QET61CM-226	22 MF	16 V	Electrolytic
C806	QET61CM-226	22 MF	16 V	Electrolytic
C807	QET61EM-107	100 MF	25 V	Electrolytic
C808	QET61EM-107	100 MF	25 V	Electrolytic
C809	QET61CM-476	47 MF	16 V	Electrolytic
C810	QET61HM-476	47 MF	50 V	Electrolytic
C811	QEN61EM-476	47 MF	25 V	Electrolytic
C812	QEN61EM-476	47 MF	25 V	Electrolytic
C813	QCF31HP-473	0.047 MF	50 V	Ceramic
C901	QET61HM-105	1 MF	50 V	Electrolytic
C903	QET61CM-476	47 MF	16 V	Electrolytic
C904	QFV71HJ-104	0.1 MF	50 V	T. Film
C905	QET61HM-475	4.7 MF	50 V	T. Film
C906	QCT25CH-101	100 pF	50 V	Ceramic
C907	QCT25CH-101	100 pF	50 V	Ceramic
C908	QET61CM-476	47 MF	16 V	Electro
C909	QFV71HJ-104	0.1 MF	50 V	T. Film
C910	QET61CM-107	100 MF	16 V	Electrolytic
C911	QET61EM-106	10 MF	25 V	Electrolytic

Resistors

Item No.	Parts Number	Description		
R101	QRD141J-102S	1 K	1/4 W	Carbon
R102	QRD141J-102S	1 K	1/4 W	Carbon
R103	QRD141J-223S	22 K	1/4 W	Carbon
R104	QRD141J-102S	1 K	1/4 W	Carbon
R105	QRD141J-273S	27 K	1/4 W	Carbon
R106	QRD141J-271S	270	1/4 W	Carbon
R107	QRD141J-124S	120 K	1/4 W	Carbon
R108	QRD141J-221S	220	1/4 W	Carbon
R109	QRD141J-124S	120 K	1/4 W	Carbon
R110	QRD141J-332S	3.3 K	1/4 W	Carbon
R111	QRD141J-103S	10 K	1/4 W	Carbon
R112	QRD141J-103S	10 K	1/4 W	Carbon
R113	QRD141J-123S	12 K	1/4 W	Carbon
R114	QRD141J-123S	12 K	1/4 W	Carbon
R115	QRD141J-103S	10 K	1/4 W	Carbon
R116	QRD141J-103S	10 K	1/4 W	Carbon
R117	QRD141J-4R7S	4.7	1/4 W	Carbon
R118	QRD141J-104S	100 K	1/4 W	Carbon
R119	QRD141J-153S	15 K	1/4 W	Carbon
R120	QRD141J-122S	1.2 K	1/4 W	Carbon
R121	QRD141J-103S	10 K	1/4 W	Carbon
R122	QRD141J-682S	6.8K	1/4 W	Carbon
R201	QRD141J-102S	1 K	1/4 W	Carbon
R202	QRD141J-102S	1 K	1/4 W	Carbon
R203	QRD141J-333S	33 K	1/4 W	Carbon
R204	QRD141J-333S	33 K	1/4 W	Carbon
R205	QRD141J-333S	33 K	1/4 W	Carbon
R206	QRD141J-333S	33 K	1/4 W	Carbon
R207	QRD141J-392S	3.9 K	1/4 W	Carbon
R208	QRD141J-392S	3.9 K	1/4 W	Carbon
R209	QRD141J-271S	270	1/4 W	Carbon
R210	QRD141J-564S	560 K	1/4 W	Carbon
R211	QRZ0062-100	10	1/4 W	Fusible
R212	QRZ0062-100	10	1/4 W	Fusible
R213	QRD141J-222S	2.2 K	1/4 W	Carbon
R214	QRD141J-271S	270	1/4 W	Carbon
R215	QRD141J-103S	10 K	1/4 W	Carbon
R216	QRD141J-564S	560 K	1/4 W	Carbon
R217	QRD141J-473S	47 K	1/4 W	Carbon

△ : Safety Parts

Others

Item No.	Parts Number	Description		
R218	QRD141J-123S	12 K	1/4 W	Carbon
R219	QRD141J-103S	10 K	1/4 W	Carbon
R220	QRD141J-102S	1 K	1/4 W	Carbon
R221	QRD141J-102S	1 K	1/4 W	Carbon
R305	QRD141J-473S	47 K	1/4 W	Carbon
R307	QRD141J-473S	47 K	1/4 W	Carbon
R403	QRD141J-683S	68 K	1/4 W	Carbon
R404	QRD141J-683S	68 K	1/4 W	Carbon
R405	QRD141J-103S	10 K	1/4 W	Carbon
R406	QRD141J-102S	1 K	1/4 W	Carbon
R407	QRD141J-184S	180 K	1/4 W	Carbon
R408	QRD141J-103S	10 K	1/4 W	Carbon
R409	QRD141J-103S	10 K	1/4 W	Carbon
R410	QRD141J-103S	10 K	1/4 W	Carbon
R411	QRD141J-822S	8.2 K	1/4 W	Carbon
R412	QRD141J-473S	47 K	1/4 W	Carbon
R413	QRD141J-104S	100 K	1/4 W	Carbon
R414	QRD141J-124S	120 K	1/4 W	Carbon
R415	QRD141J-123S	12 K	1/4 W	Carbon
R416	QRD141J-103S	10 K	1/4 W	Carbon
R417	QRD141J-223S	22 K	1/4 W	Carbon
R418	QRD141J-103S	10 K	1/4 W	Carbon
R419	QRD141J-123S	12 K	1/4 W	Carbon
R420	QRD141J-103S	10 K	1/4 W	Carbon
R426	QRD141J-822S	8.2 K	1/4 W	Carbon
R427	QRD141J-332S	3.3 K	1/4 W	Carbon
R428	QRD141J-822S	8.2 K	1/4 W	Carbon
R429	QRD141J-273S	27 K	1/4 W	Carbon
R501	QRD141J-223S	22 K	1/4 W	Carbon
R502	QRD141J-472S	4.7 K	1/4 W	Carbon
R503	QRD141J-102S	1 K	1/4 W	Carbon
R504	QRD141J-223S	22 K	1/4 W	Carbon
R505	QRD141J-103S	10 K	1/4 W	Carbon
R505	QRD141J-103S	10 K	1/4 W	Carbon
R506	QRD141J-223S	22 K	1/4 W	Carbon
R507	QRD141J-473S	47 K	1/4 W	Carbon
R605	QRD141J-391S	390	1/4 W	Carbon
R606	QRD141J-102S	1 K	1/4 W	Carbon
R801	QRD141J-392S	3.9 K	1/4 W	Carbon
R802	QRD141J-181S	180	1/4 W	Carbon
R803	QRD141J-392S	3.9 K	1/4 W	Carbon
R804	QRD141J-181S	180	1/4 W	Carbon
R805	QRD141J-561S	560	1/4 W	Carbon
R806	QRD141J-473S	47 K	1/4 W	Carbon
R807	QRD141J-472S	4.7 K	1/4 W	Carbon
R808	QRD148J-271S	270	1/4 W	Carbon
R810	QRD141J-223S	22 K	1/4 W	Carbon
R811 Δ	QRZ0062-100	10	1/4 W	Fusible
R812	QRD148J-222S	2.2 K	1/4 W	Carbon
R901	QRD141J-103S	10 K	1/4 W	Carbon
R909	QRD141J-223S	22 K	1/4 W	Carbon
R910	QRD141J-223S	22 K	1/4 W	Carbon
R911	QRD141J-223S	22 K	1/4 W	Carbon
R912	QRD141J-223S	22 K	1/4 W	Carbon
R913	QRD141J-223S	22 K	1/4 W	Carbon
R914	QRD141J-103S	10 K	1/4 W	Carbon
R915	QRD141J-681S	680	1/4 W	Carbon
R916	QRD141J-101S	100	1/4 W	Carbon
R917	QRD141J-101S	100	1/4 W	Carbon
R918	QRD141J-473S	47 K	1/4 W	Carbon
R919	QRD141J-473S	47 K	1/4 W	Carbon
R920	QRD141J-223S	22 K	1/4 W	Carbon
VR402	QVP4A0B-103	10 K	0.1 W	Variable
R301	ERGS6XK-103	10 K		Resistor Array
R601	ERGS8XK-473	47 K		Resistor Array
R602	ERGS7XK-473	47 K		Resistor Array
R603	ERGS7XK-103	10 K		Resistor Array
R604	ERGS9XK-103	10 K		Resistor Array

Δ : Safety Parts

Item No.	Parts Number	Description
	QMV5005-003	3P Plug Ass'y
	QMV5005-005	5P Plug Ass'y
	QMV5005-006	6P Plug Ass'y
	QMV5005-008	8P Plug Ass'y
	QMV5005-009	9P Plug Ass'y
	QMV5005-010	10P Plug Ass'y
	E67764-007	Terminal Ass'y
	EWT011-064	Terminal Wire
	E10889-102	Circuit Board
	SBST3008Z	Screw
	E70588-001	Heat Sink
	E67910-001	Spacer
S401	QSS2301-011	Slide Switch
S501	QSP2256-001	Push Switch
S502	QSS2301-011	Slide Switch
S901	ESP0001-007	Push Switch
S902	ESP0001-007	Push Switch
S903	ESP0001-007	Push Switch
S904	ESP0001-007	Push Switch
S905	ESP0001-007	Push Switch
S906	ESP0001-007	Push Switch
S907	ESP0001-007	Push Switch
S908	ESP0001-007	Push Switch
S909	ESP0001-007	Push Switch
S910	ESP0001-007	Push Switch
S911	ESP0001-007	Push Switch
S912	ESP0001-007	Push Switch
S913	ESP0001-007	Push Switch
S914	ESP0001-007	Push Switch
S915	ESP0001-007	Push Switch
S916	ESP0001-007	Push Switch
S917	ESP0001-007	Push Switch
FL601	ELU0001-020	FL Tube
L601	EQL3001-102KY	Inductor
X901	ECX0004-190KU	Ceramic Resonator

MC953D Motor Drive P.C. Board Ass'y

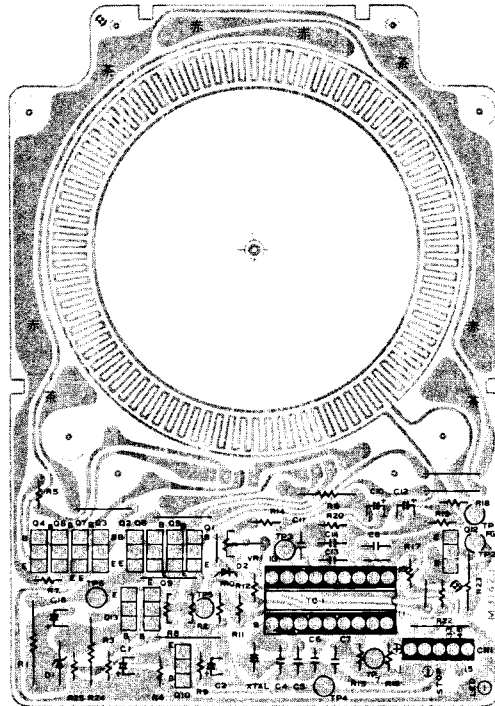

Fig. 8

IC

Item No.	Parts Number	Rating	Description
IC1	VC4052		IC

Transistors

Item No.	Parts Number	Rating	Description
Q1	2SC2120(O,Y)		Silicon Toshiba
Q2	2SC2120(O,Y)		Silicon Toshiba
Q3	2SA950(O,Y)		Silicon Toshiba
Q4	2SA950(O,Y)		Silicon Toshiba
Q5	2SA1015(Y,GR)		Silicon Toshiba
Q6	2SA1015(Y,GR)		Silicon Toshiba
Q7	2SC1815(Y,GR)		Silicon Toshiba
Q8	2SC1815(Y,GR)		Silicon Toshiba
Q9	2SA1015(GR)		Silicon Toshiba
Q10	2SC1815(GR)		Silicon Toshiba
Q12	2SC1815(Y,GR)		Silicon Toshiba
Q13	2SC2120(O,Y)		Silicon Toshiba

Capacitors

Item No.	Parts Number	Rating	Description
C1	QET41HM-474	0.47 μ F 50 V	Electrolytic
C2	QET41HM-225	2.2 μ F 50 V	Electrolytic
C3	QET41HM-105	1 μ F 50 V	Electrolytic
C4	QCT25CH-101	100 pF 16 V	Ceramic
C5	QCT25CH-101	100 pF 16 V	Ceramic
C6	QFM41HK-223	0.022 μ F 50 V	Film
C7	AWS104G-50	0.1 μ F 50 V	Polypropylene
C8	QCF31HP-103	0.01 μ F 50 V	Ceramic
C9	QET41CM-336	33 μ F 16 V	Electrolytic
C10	QET41HM-105	1.0 μ F 50 V	Electrolytic
C11	QCT25UJ-330	33 pF 50 V	Ceramic
C12	QET41EM-106	10 μ F 25 V	Electrolytic
C13	QCF31HP-103	0.01 μ F 50 V	Ceramic
C14	QCY31HK-102	0.001 μ F 50 V	Ceramic
C15	QCF31HP-103	0.01 μ F 50 V	Ceramic
C16	QET41CM-106	10 μ F 16 V	Electrolytic
C17	QCF31HP-103	0.01 μ F 50 V	Ceramic
C18	QCF31HP-103	0.01 μ F 50 V	Ceramic
C19	QCF31HP-223	0.022 μ F 50 V	Ceramic
C20	QCF31HP-223	0.022 μ F 50 V	Ceramic

Diode

Item No.	Parts Number	Rating	Description
D1	RD5.6EL3		Zener

Resistors

Item No.	Parts Number	Rating	Description
R1	QRX019J-2R7S	2.7 Ω 1 W	Metal
R2	QRD167J-181	180 Ω 1/6 W	Carbon
R3	QRD167J-101	100 Ω 1/6 W	Carbon
R4	QRD167J-332	3.3 k Ω 1/6 W	Carbon
R5	QRD167J-821	820 Ω 1/6 W	Carbon
R6	QRD141J-102S	1 k Ω 1/4 W	Carbon
R7	QRD167J-471S	470 Ω 1/6 W	Carbon
R8	QRD167J-102	1 k Ω 1/6 W	Carbon
R9	QRD167J-103	10 k Ω 1/6 W	Carbon
R10	QRD167J-163	16 k Ω 1/6 W	Carbon
R11	QRD167J-474	470 k Ω 1/6 W	Carbon
R12	QRD167J-104	100 k Ω 1/6 W	Carbon
R13	QRD167J-913	91 k Ω 1/6 W	Carbon
R14	QRD167J-104	100 k Ω 1/6 W	Carbon
R15	QRV146F-2702	27 k Ω 1/4 W	Metal
R16	QRD167J-474	470 k Ω 1/6 W	Carbon
R17	QRD167J-101	100 Ω 1/6 W	Carbon
R18	QRD167J-102	1 k Ω 1/6 W	Carbon
R19	QRD167J-104	100 k Ω 1/6 W	Carbon
R20	QRD167J-105	1 M Ω 1/6 W	Carbon
R21	QRD167J-101	100 Ω 1/6 W	Carbon
R22	QRD167J-183	18 k Ω 1/6 W	Carbon
R23	QRD141J-101S	100 Ω 1/4 W	Carbon
R24	QRD121J-271	270 Ω 1/2 W	Carbon
R25	QRD167J-153	15 k Ω 1/6 W	Carbon

Δ : Safety Parts

Others

Item No.	Parts Number	Rating	Description
X1	LA-1157 QMV5004-005 VHE-101 M31469		X'tal Micro Connector Hall Generator P. Circuit Board

Muting P.C. Board Ass'y

Note

The symbols (赤, 黒, 白.....etc.) on P.C. Board surface are factory process only.

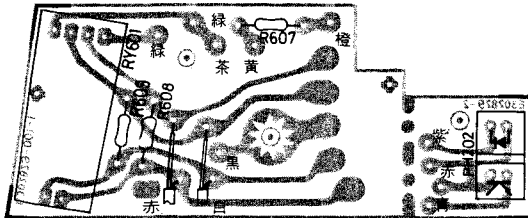

Fig. 9

Item No.	Parts Number	Description		
R607	QRD148J-102	1 K	1/4 W	Carbon Resistor
R608	QRD148J-474	470 K	1/4 W	Carbon Resistor
R609	QRD148J-474	470 K	1/4 W	Carbon Resistor
RY601	ESK2D12-213			Relay
PH202	TLP-801A-V			Phot Intalaptor
	E302829-001			P.C. Board

Sensor P.C. Board Ass'y

Note

The symbols (赤, 黒, 白.....etc.) on P.C. Board surface are factory process only.

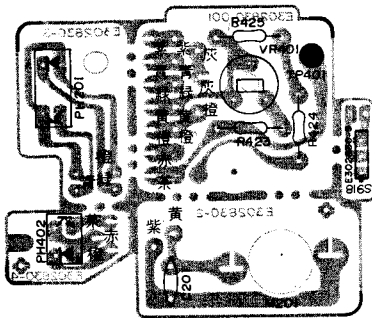

Fig. 10

Item	Part Number	Description		
C405	QCF21HP-102	1000 pF	50 V	Ceramic Capacitor
R423	QRD148J-103	10 K	1/4 W	Carbon Resistor
R424	QRD148J-820	82	1/4 W	Carbon Resistor
R425	QRD148J-820	82	1/4 W	Carbon Resistor
VR401	QVP4A0B-224	220 K	0.1 W	Variable Resistor
S918	QSS1201-034			Slide Switch
M201	E300763-005			Motor
PH201	TLP801A-V			Phot Intalaptor
PH402	RPR-359F			Intalaptor
TP401	E43727-002			Tab
	E302830-002			P.C. Board

Signal P.C. Board Ass'y

Note

The symbols (赤, 黒, 白.....etc.) on P.C. Board surface are factory process only.

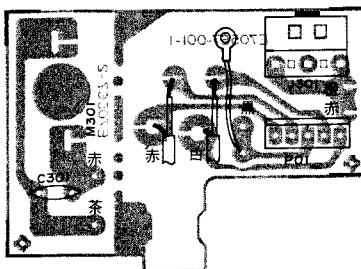

Fig. 11

Item	Part Number	Description		
C301	GEN51HM-225	2.2 MF	50 V	Non Pole Capacitor
J301	QMS3533-001			Jack
P01	QMV5004-005			5P Plug Ass'y
M301	E300763-005			Motor
	E71219-001			Sheeld Bracket
	E61215-001			P.C. Board

Packing Materials and Part Numbers

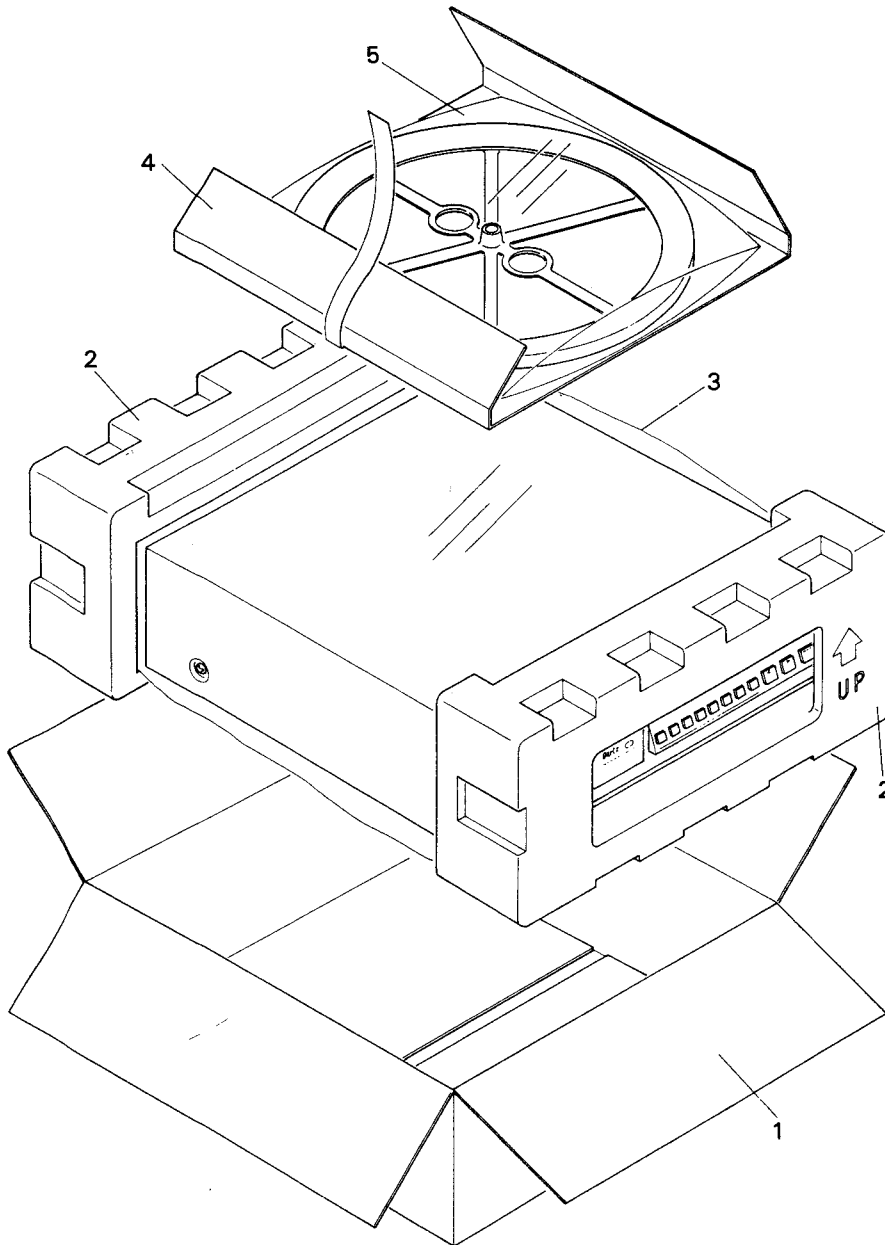

Fig. 12

The Marks for Designated Areas.

- J U.S.A.
- C Canada
- E Europe
- G West Germany
- ES Spain
- P,PG U.S.Military Market
- BS U.K.
- A Australia
- U Other Countries
- No mark All areas.

No.	Part Number	Part Name	Q'ty	Description	Area
1	PK-QLG90E (B)	Packing Case	1	E24775-001	
	PK-QLG90ES	Packing Case	1	E24775-002	ES
2	NZ-QLG90	Fillers	1	E24601-001	
3	E300196-031	Envelope	1		
	E300196-031B	Envelope	1		BS
4	E303152-001	Sheet	1		
5	E300196-039	Envelope	1		
	E300196-039B	Envelope	1		BS
	E35497-017	Caution Sheet	1	110 V	P
	E35497-019	Caution Sheet	1	220 V	U,PG
	E35246-001	Serial Label	1		J,C,U,P,PG,A
	E35246-004	Serial Label	1		E,ES
	E35246-006	Serial Label	1		G

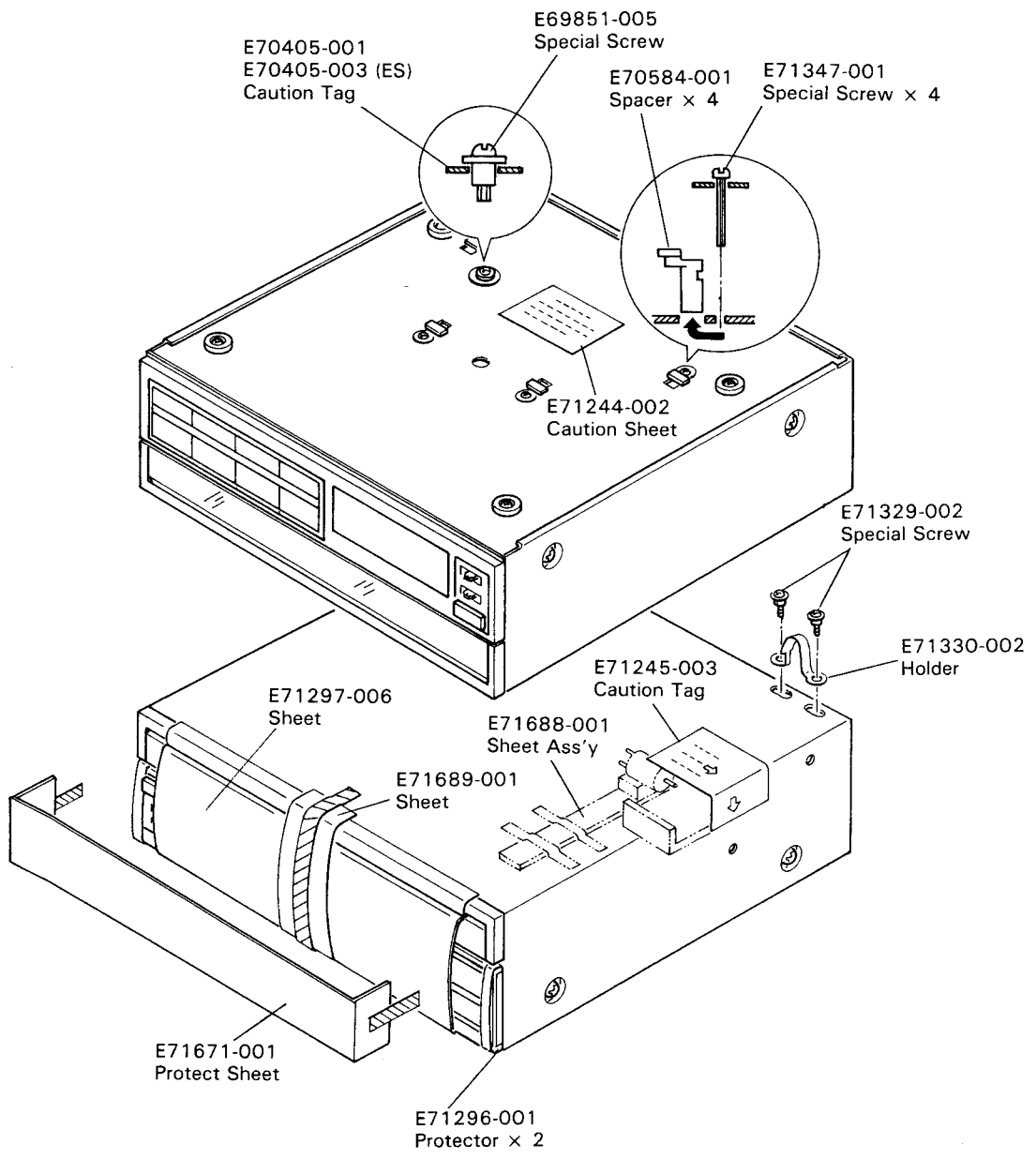

Fig. 13

Accessories List

Part Number	Part Name	Description	Areas
E30580-1197A E30580-1197ABS BT20047A BT20025F BT20047A	Instruction Book Instruction Book Warranty Card Warranty Card Warranty Card		J,C,U,P,PG,E,A,G,ES BS J C P,PG
BT20029C BT20060 BT20064 BT20071 BT20046B	Warranty Card Warranty Card Warranty Card SVC Center List Service Information Card		A BS G C J,P,PG
BT20044D BT20066 E303495-001 E35497-019 E35497-017	Service Information Sheet EEC Agency Caution Sheet Caution Sheet Caution Sheet		J BS,G U,PG P
E04056 E66329-001 EWP805-001 E66416-003 E71090-001	Siemens Plug EP Adaptor 1P Plug Cord Envelope Cap	for Warranty Card	U,PG J
E300196-010 E300196-010B	Envelope Envelope		BS

The Marks for Designated Areas.

J	U.S.A.	P,PG	U.S.Military Market
C	Canada	ES	Spain
E	Europe	BS	U.K.
G	West Germany	U	Other Countries
A	Australia		

16. Power Cord Connections in Different Areas

■ for U.K., Australia & Europe

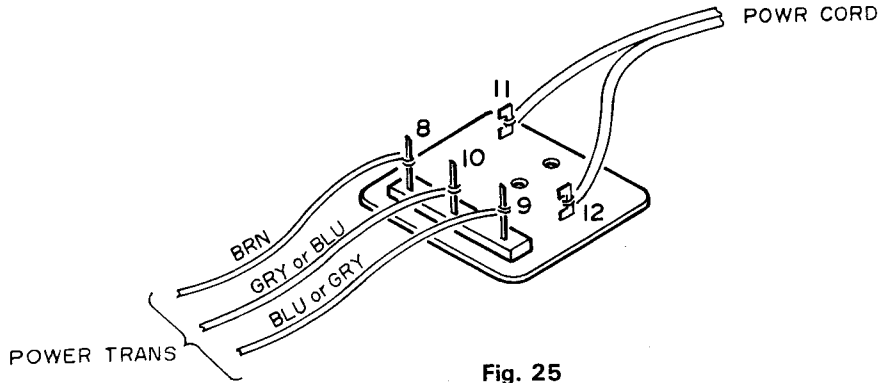

Fig. 25

	U.K, A	E
8	BRN	BRN
9	GRY	BLU
10	BLU	GRY

■ for U.S. Military Market & Other Countries

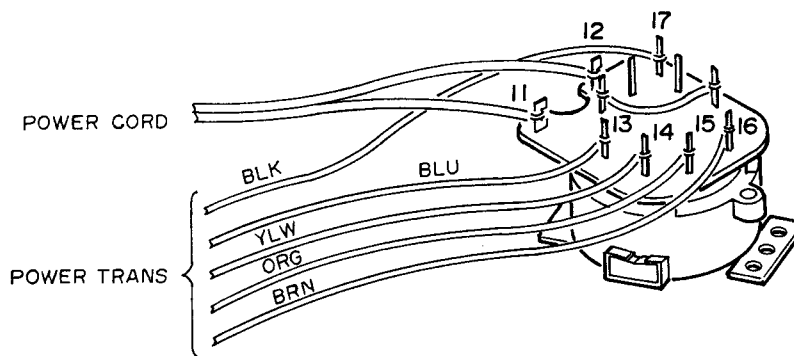

Fig. 26